

JUNE, 1936

# Radio Engineering

VOL. XVI

NO. 6

DESIGN • PRODUCTION • ENGINEERING

- Broadcast Receivers
- Auto-Radio Receivers
- Electric Phonographs
- Sound Recorders
- Sound Projectors
- Audio Amplifiers
- P-A Equipment
- Electronic Control Devices
- Testing and Measuring Equipment
- Television Apparatus
- Loudspeakers
- Components
- Tubes
- Photocells



ATTENTION OR:

- |                  |                  |
|------------------|------------------|
| Pres. _____      | V. Pres. _____   |
| Gen. Mgr. _____  | Adv. Mgr. _____  |
| Eng. Dept. _____ | Prod. Mgr. _____ |
| Sales Mgr. _____ | Pur. Agt. _____  |

## The Journal of the Radio and Allied Industries

# CERAMIC PROGRESS

*Alsimag & Lava*



● The several ALCO ceramics are carefully designed to suit satisfactorily various engineering requirements. During the past year our research laboratory has released the superior Steatite ceramics Alsimag 192, Alsimag 196, Alsimag 197 and Alsimag 202.

The high dielectric constant and low power factor makes Alsimag 192 an ideal ceramic for use in condensers. The very low loss factor of ultra-steatite Alsimag 196 recommends this body for all high frequency applications. The unusual mechanical properties make it obviously superior in its field.

Designed to meet the rigid requirements where high temperatures are encountered and used especially by range manufacturers, Alsimag 197 has been enthusiastically received.

Alsimag 202 with its low coefficient of expansion will be of interest to those engineers seeking a ceramic body with excellent thermal shock properties.

Our standard Alsimag 35 has for many years met the requirements of engineers for a dense Steatite body with low electrical losses and exceptional mechanical strength.

Alsimag 72 for thermocouples and Alsimag 203, a porous body for resistance, have special applications well known to engineers. Lava (machined Steatite), where limited quantities or watch-like accuracy are desired—experimental samples machined from the crude material without any die expense. Extensively employed in electronic tubes.

Our engineers and laboratories are at your disposal to work out a body to meet special needs.

If ALCO supplies your ceramics your engineers are not limited to one body.

*Write us today for additional information and samples of such Alsimag bodies as are of interest to you, instructing your Purchasing Department to secure our attractive prices on your insulating parts.*

*34th Year of Ceramic Leadership*

**AMERICAN LAVA CORPORATION - Chattanooga, Tenn.**

OUR OWN BRANCH OFFICES  
 LOS ANGELES  
 SAN FRANCISCO  
 ST. LOUIS  
 CHICAGO  
 CLEVELAND  
 BOSTON  
 NEW YORK  
 PHILADELPHIA

# RADIO ENGINEERING

REG. U. S. PATENT OFFICE

W. W. WALTZ • Editor

## CONTENTS FOR JUNE

### FEATURES

EDITORIAL .....	2
AUDIO COMPENSATING SYSTEMS..... By A. W. Barber	5
INDIRECTLY-HEATED CATHODES..... By G. D. O'Neill	8
POWER AMPLIFIER DESIGN..... By Paul Adorjan	12
IMPROVING LOW-FREQUENCY RESPONSE..... By R. D. Rettenmeyer	14
OIL CONDENSER CHARACTERISTICS.....	16
CIRCUIT CONSIDERATIONS IN THE USE OF BEAM POWER TUBES By W. N. Durham	20

### DEPARTMENTS

BOOK REVIEWS .....	7
NOTES AND COMMENT:	
WESTERN ELECTRIC AIRCRAFT RECEIVER.....	22
POLAROID STRAIN DETECTOR.....	23
NEW TUBE VISUALIZES ELECTRONS.....	24
INAUGURATION OF DAILY TELEVISION BROADCAST SCHEDULE	24
NEWS OF THE INDUSTRY.....	25
NEW PRODUCTS .....	26
RADIO ENGINEERING BUYERS GUIDE.....	30
INDEX OF ADVERTISERS.....	33

Copyright 1936—Bryan Davis Publishing Co., Inc.

VOL. XVI

Member Audit Bureau of Circulations

NO. 6

### COVER ILLUSTRATION

A WESTINGHOUSE ELECTRONIC TUBE; PATTERN DISTORTED BY FIELD OF MAGNET HELD ALONG-SIDE THE BULB

PUBLISHED  
MONTHLY  
by  
the

BRYAN S. DAVIS • President      SANFORD R. COWAN • Advertising Manager  
JAS. A. WALKER • Secretary      A. B. CARLSEN • Circulation Manager

**BRYAN DAVIS PUBLISHING CO., Inc. 19 East 47th St., NEW YORK CITY Telephone PLaza 3-0483**

CHICAGO OFFICE—608 S. Dearborn St.—C. O. Stimpson, Mgr. Telephone: Wabash 1903

CLEVELAND OFFICE—10515 Wilbur Ave.—J. C. Munn, Mgr. Telephone: Republic 0905-J

MELBOURNE, AUSTRALIA—McGill's Agency

WELLINGTON, NEW ZEALAND—Te Aro Book Depot

Entered as second class matter August 26, 1931, at the Post Office at New York, N. Y., under Act of March 3, 1879. Yearly subscription rate \$2.00 in United States and Canada; 25 cents per copy. \$3.00 in foreign countries; 35 cents per copy.

JUNE, 1936

Page 1

# Editorial

## IN THIS ISSUE

RADIO ENGINEERING IS proud to present a feature which we believe is unique in the field of technical publications. Inserted between pages 16 and 19 will be found the first of a series of charts which we hope will prove to be of real value to engineers.

The use of charts in itself represents no great degree of originality. However, we would like to direct our readers' attention to the perforated page, making for easy removal from the magazine; the guide marks for standard three-ring notebook punching; and the heavy paper stock which will help to preserve these charts long past the time when a torn out page of regular magazine stock would be much the worse for wear.

It is our intention to present not only many new and distinctive charts, but also to use some of the old standbys. We believe that many of these are of enough importance to the profession to warrant their inclusion, and that they will be welcomed by engineers who like to have pertinent data available at their fingertips.

• • •

## QUALITY

THE RADIO INDUSTRY is evidently going to educate the public to quality, or else! We suspect that it's going to be a tough job, but it is high time that something is done about it.

Thus far the broadcasters have been setting the pace—a situation somewhat in reverse of the usual procedure of waiting for the public to demand improvements. The improvement in the transmitting equipment—including wire lines, microphones, and all associated equipment—is not yet very obvious to the listener.

About the only possibility of further improvement which might be apparent at the receiving end lies in the use of automatic volume compression somewhere in the transmitting circuits. At the present time far too many programs are badly monitored, so much so that the use of volume expansion at the receiver is of questionable value. However, volume expansion is needed to assist in the educative campaign. It is sur-

prising how many persons there are who realize that there is a difference between the Philharmonic—to cite a representative program—as heard at Carnegie Hall and the Philharmonic heard over the air, but who have not even the faintest idea that the difference may be largely one occasioned by the necessity of “squeezing” the program through the circuits. These persons aren't inclined to decry the radio version because of a restricted frequency range—authorities to the contrary notwithstanding, we'd like to bet that very few people have the auditory range with which they are credited—but rather because of a lack of what they term “naturalness”; that is, they just don't get the impression which the orchestra itself imparts. Chalk that up to the lack of proper compression and expansion.

• • •

## CABINETS AND SPEAKERS

It is interesting, and encouraging, to note that real attention is being given to the hitherto neglected problem of cabinet resonance. Not only suspected, but definitely proved long ago to be the source of much of the distortion to which even the public objected—except those who like their programs “mellow”—this problem has been attacked from several angles and much good has been accomplished.

Loudspeakers have undergone some important changes lately, although these changes aren't so evident because of distortion and generally poor quality originating in other parts of the set. Of course, no one claims that speakers have reached the ultimate of perfection, but assisted by such things as the reduction of cabinet resonance effects, we can look to the speakers at least partially to carry their end of the quality problem. One big obstacle, as we see it, will be in providing speakers which can handle the output power of 6L6 tubes. Talk about reserve power all you like; the fact still remains that this reserve will often be called upon to carry the program peaks, and this means speakers that can handle thirty and more watts of power—few present models can do that!

# MORLEN BEAM TUBE AMPLIFIERS



## A SUPERB ACHIEVEMENT IN PUBLIC ADDRESS AMPLIFIERS

THE new MORLEN MC60 and MC120 amplifiers, using the 6L6 Beam-Power Tubes in the output stages, make available to the rental operator and p.a. installer, two amplifiers, unexcelled in operating features and performance. The 6L6 beam-tube is a tetrode of high-power input sensitivity—the *utmost* in performance is obtained from tubes of this type by their use in the recently announced MORLEN "Power-Driver" circuit, as used in the latest MC models.

THE MC60 and MC120 amplifiers incorporate universal, dual channel input, with full mixer control, a main gain control, and tone control. The output is a dual winding transformer having 500 ohms impedance across one winding and 15 ohms tapped at 8 and 4 ohms across the second winding. Practically any combination of speakers or other load devices can be operated from the MC output. Also included is a dual AC receptacle, a fuse under protective cover and a main AC ON and OFF switch. All MC amplifiers are complete on one chassis, from input to output and in power ranges from 19 to 120 watts.

*Due to the elimination of interstage transformers (a feature of the "Power-Driver" circuit), the frequency response of the MC 6L6 amplifiers is essentially flat from 40 to 14,000 cycles, thruout a wider power range than with any other system.*

*Write Dept. RE. 6 for detailed specifications.*

**MORLEN ELECTRIC COMPANY, INC.**  
**60 W. 15TH ST. - NEW YORK, N. Y.**

# SHAKEPROOF LOCK WASHERS

## Each Twisted Tooth Acts as a Powerful Resilient Spring

**B**ECAUSE Shakeproof Lock Washers are made of high grade spring steel and are specially heat treated and hardened, they possess a degree of "Spring Action" that is truly exceptional. The combination of this resilient power and Shakeproof's exclusive twisted-tooth design produces a posi-

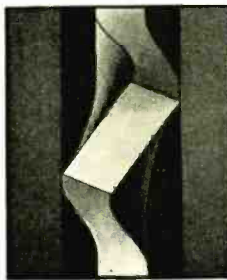

tive, solid contact between both nut and work surfaces that even vibration cannot loosen. Give your product the absolute protection of this superior locking method—send for free testing samples today!

**SHAKEPROOF LOCK WASHER COMPANY**  
*Distributors of Shakeproof Products* Manufactured by Illinois Tool Works  
 Chicago, Illinois  
 2509 N. Keeler Avenue

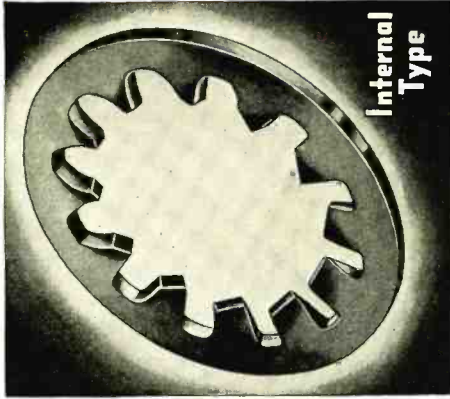

Internal Type

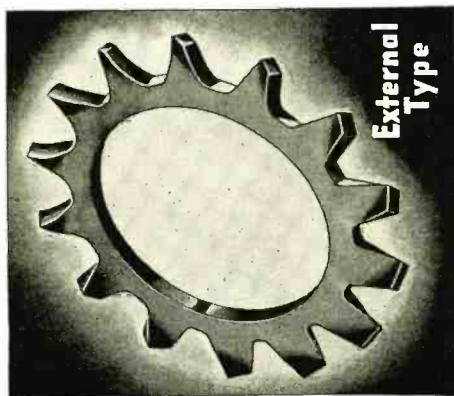

External Type



## When Radio Parts Are Wanted They Want Them Quick

One answer. It's unanimous—they do! And there's one fast, dependable way to get parts or anything else shipped—use Railway Express. No guesswork then, but top-speed, modern service all the way. To get it, you have only to phone the nearest Railway Express office. A fast motor truck will pick up your shipments, they will be forwarded at passenger train speed, delivered promptly on arrival (C.O.D. if you so specify. It's all the same to us and just as quick.)

With 23,000 Railway Express offices at your disposal across the continent there are few customers we can't reach for you, and in every case the whole transaction is clinched for sureness by double receipts—one to you on pick-up, with liability up to \$50.00 included on every package—another to us on delivery proving arrival right and in good condition. Low rates.

Merely telephone the nearest Railway Express office for service or information.

**RAILWAY EXPRESS**  
 AGENCY INC.  
 NATION-WIDE RAIL-AIR SERVICE

# RADIO ENGINEERING

FOR JUNE, 1936

## AUDIO COMPENSATING SYSTEMS

by A. W. BARBER\*

THE STEADY STATE solution of simple electrical networks may be easily obtained. All too often the steady state solution is accepted as the complete solution, probably due to the widely accepted belief that since periodic waves may be expressed by a Fourier series, circuit response may be analyzed on a steady state basis for practical uses. Frequency compensating circuits are evidently often designed on this basis, but the "queer" results obtained should not be tolerated. The actual trouble is that the transient response must be taken into account as well.

The necessity for including the transient response, when dealing with audio-frequency circuits, may be easily demonstrated. Percussion band instruments, many sound effects, static and other waves are seriously altered by transient response troubles. The use of resonant

\*Consulting Engineer.

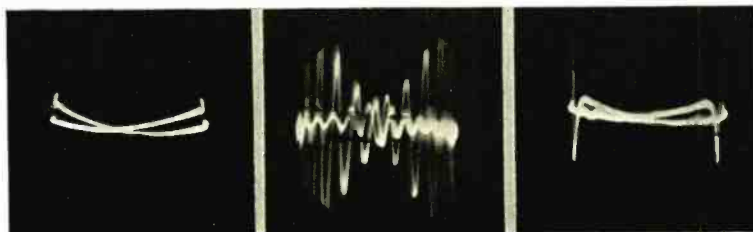

Fig. 2. Oscillograms of various degrees of compensation.

circuits having less than critical damping will generate damped oscillations when excited by these sources, and the result is "hang-over" and jumbled or ringing sounds in the reproduction. These results seriously affect the fidelity of reproduction, often more seriously than is suspected.

The audio compensating circuit to be described was designed to give a high

ratio of low- and high-frequency compensation and at the same time to employ only circuits having damping equal to or greater than critical. It comprises high frequency, low frequency and reference level independently-controlled circuits, and may be applied to radio, public-address or phonograph reproduction systems. The basic arrangement is shown in Fig. 1 and consists of a three part impedance, having the desired characteristic, used as a plate load of a high plate resistance tube such as a type 77. The high-frequency compensating impedance consists of inductance  $L_1$  tuned by condenser  $C_1$  and shunted by level control resistor  $R_1$ . The low-frequency compensating circuit consists of inductance  $L_2$  tuned by condenser  $C_2$  and shunted by level control resistor  $R_2$ . The reference or middle register gain of the system is determined by the value of the reference level control resistor  $R_3$ .

In designing these circuits the relation

$$R_c = \sqrt{\frac{L}{4C}} = \frac{1}{2\omega C} = \frac{L\omega}{2}$$

is used, where  $R_c$  is the critical damping

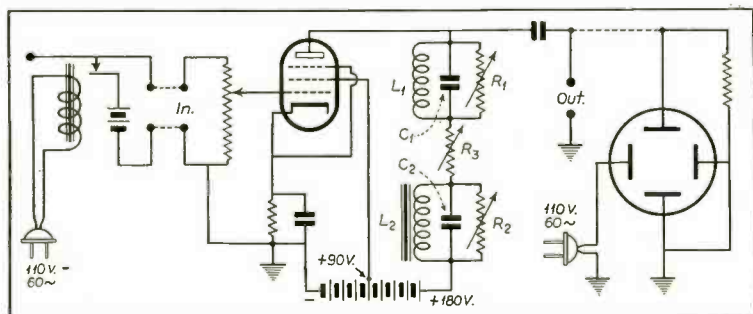

Fig. 1. The basic compensating circuit.

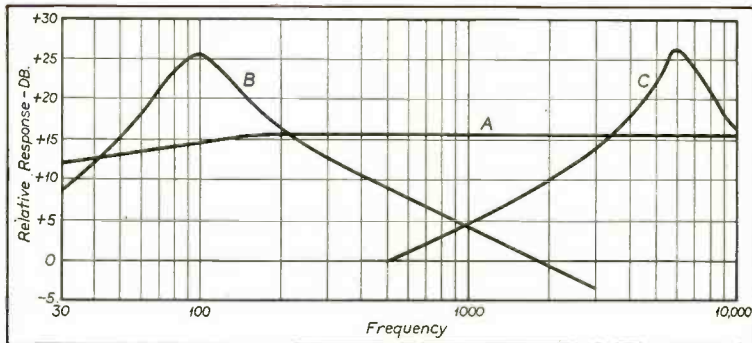

Fig. 3. Gain vs. frequency characteristic of each of the networks of Fig. 1.

resistance or the maximum value of the shunt control resistors. For instance, the compensation control resistors may be chosen as 50,000 ohms each and if 6000 cycles is to be the high-frequency peak gain point, the above formula gives  $L_1 = 2.7$  henrys and  $C_1 = 260$  micro-microfarads while if 100 cycles is to be the low-frequency peak point, the formula gives  $L_2 = 159$  henrys and  $C_2 = 0.016$  microfarad. The reference level control resistor  $R_3$  should have a maximum value of about 5000 ohms. These constants permit a wide range of compensation ratios, but at no setting will oscillations be generated.

Fig. 1 includes apparatus for checking the transient response of the compensating system. A synchronous interrupter is shown for connecting a bias battery to the grid of the amplifier tube, and a cathode-ray tube is shown connected to the plate circuit of the tube for observing the output waveform. The interrupter was driven from the 60-cycle line voltage and the horizontal sweep of the cathode-ray tube was also taken from the 60-cycle line. The interrupter was not polarized and was adjusted to make contact just at the maximum travel points of the vibrator arm. This gave 120 contacts per second, resulting in a sharp grid impulse at the positive and negative peak points of the 60-cycle voltage.

Fig. 2A shows the output waveform obtained on the cathode-ray tube with both compensating circuits shorted, but with the reference level gain control advanced and the synchronous interrupter impulsing the grid. The sharp voltage pulses will be seen at each end of the horizontal sweep travel.

Fig. 2B shows the cathode-ray tube pattern obtained with maximum high-frequency compensation adjustment. The sharp pulses are greatly exaggerated, but still there is no oscillation. This pattern demonstrates qualitatively the large amplification of the high-frequency components which is possible

without adding oscillatory distortion to the system.

Fig. 2C shows the cathode-ray tube pattern resulting from removing the shunt  $R_1$  from the high-frequency compensating circuit. While the amplification of the high-frequency component is somewhat greater than in the criti-

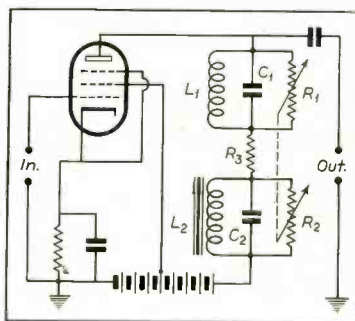

Fig. 5. A simplification of the circuit of Fig. 1.

cally damped case, the damped oscillation following each pulse is very undesirable. Such a circuit would add these oscillations to every sharp impulse traversing the system. A number of compensation systems have been examined in which the results were very

similar to this. It is not hard to see why these systems were not all that could be desired from a fidelity standpoint; in some cases the reproduction was distinctly unpleasing.

Having designed the compensating circuits based on the critical damping theory and checked the results on a cathode-ray oscillograph, we may proceed to make conventional steady state measurements. In Fig. 3 is shown the gain vs. frequency characteristics of each of the three partial circuits taken alone. Curve A shows the frequency characteristic of the reference gain circuit  $R_3$  taken with  $R_1$  and  $R_2$  set at zero. Curve B shows the frequency characteristic of the low-frequency compensation circuit  $L_2$ ,  $C_2$  and  $R_2$  taken with  $R_1$  at maximum resistance and  $R_3$  and  $R_3$  shorted. Curve C shows the frequency characteristic of the high-frequency compensation circuit  $L_1$ ,  $C_1$  and  $R_1$  taken with  $R_1$  set at maximum resistance position and with  $R_2$  and  $R_3$  set at zero.

The use of an amplifying tube having a very high plate resistance yields gains which are proportional to the plate load impedance as long as the sum of the impedances is small compared to the plate resistance. Each of the impedances and even their sum is small compared to the plate resistance of the type 77 tube. Thus each of the curves of Fig. 3 may be considered either as impedance or gain curves and may be added as such. Accurately speaking, of course, there is a phase angle associated with each curve, but it is small and practically it may be disregarded in designing these circuits or in predicting their performance.

The legitimacy of adding impedance or gain curves to obtain composite gain curves was checked and two typical results are shown in Fig. 4. Curve A was taken with reference gain control resistor at maximum gain position and compensation control resistors  $R_1$  and  $R_2$  advanced slightly. The result is a flat

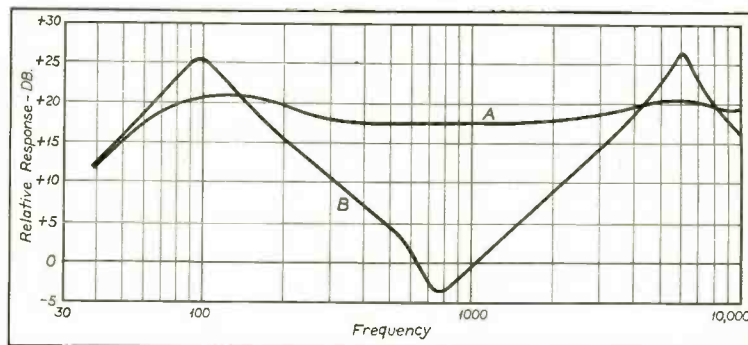

Fig. 4. Composite gain vs. frequency curves.



medium-frequency region and a 3 db rise at each end of the band. Curve B was taken to show the other extreme of compensation with reference gain control resistor  $R_3$  at zero and both high- and low-frequency controls at maximum resistance settings. The maximum gain points are at 100 and 6000 cycles and are approximately 30 db above the minimum gain point at 775 cycles. The minimum gain from the composition of the curves of Fig. 3 occurs at 1000 cycles. This difference is due to the phase relations, but it will be noted that the practical result is a slight shift in the minimum gain point and an increase in the compensation ratio.

This present circuit was designed and used for compensation in the broadcasting of electrical recordings from the high-fidelity broadcasting station, W2XR, and as such was used in its most complicated form. For home use in radio or phonograph applications a simplification of control may be desirable. Fig. 5 shows one such simplified circuit. The reference gain deter-

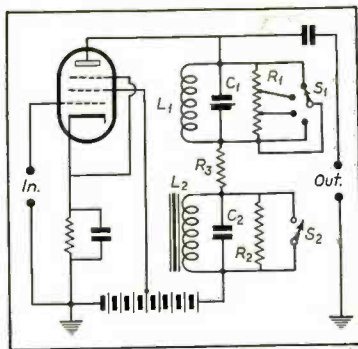

Fig. 6. Another circuit providing variable compensation.

mining resistor  $R_3$  is fixed and the high- and low-frequency gain determining resistors  $R_1$  and  $R_2$  are ganged together. It has been found that for faithful reproduction if the highs are increased, the lows must be increased as well to maintain a good balance. Considerable

variation in operation may be secured by using control resistors having different rates of variation and/or different maximum values. By making  $R_3$  variable and connecting it so as to vary in a direction opposite to  $R_1$  and  $R_2$  still further variation may be obtained.

Fig. 6 shows another method of using the circuits in which the reference gain is fixed by the use of a fixed resistor  $R_3$ , the low frequency or bass compensation may be thrown in or out by the shorting switch  $S_2$  and the high-frequency compensation is made variable in steps by means of the tap switch  $S_1$ . A three circuit, five or six position switch may also be used to obtain five or six fixed combinations of control operating from a single knob.

The particular use to which the compensating circuit is put together with the designing engineer's interpretation of the use will dictate the type of control and the amount of compensation to use. It is felt that the system is fundamentally very flexible permitting almost any desired interpretation.

## BOOK REVIEWS

*RADIO ENGINEERING HANDBOOK*, second edition, 850 pages, flexible covers. Published by McGraw-Hill Book Co., New York, N. Y. Price \$5.00.

We note a great improvement in this second edition as compared with the first. There is more engineering—which, after all, is what one expects to find in a handbook—and less textbook material.

The greatest difficulty about handbooks is exemplified here—much of the material is obsolete before the book goes to press. But the basic material—which doesn't change like fashions—is sound and as pertinent today as yesterday. However, we could use more of these unchanging fundamentals. For instance, the subject of equalizers and filters is awkwardly handled; there is very little discussion of the principles of high-fidelity r-f circuits; and, much to this reviewer's surprise, the section on sound pictures still occupies space in a radio engineering handbook.

On the other hand, we find it difficult to find a suitable comparison between the new section on audio circuits and that tritely-done attempt in the previous edition. The chapter on broadcasting has been expanded to the point where it is of real value; similar remarks might be made of the sections on

antennas, aircraft radio and receiver design.

If for no other reason than that it provides a quick reference to a great many subjects in radio, the handbook should be welcomed by the profession.

*ENGINEERING HANDBOOK OF THE NATIONAL ASSOCIATION OF BROADCASTERS*, by James C. McNary, published by the National Association of Broadcasters, National Press Building, Washington, D. C., price \$10.00.

The "NAB Engineering Handbook," which has only recently been prepared and which is being furnished to member stations, is a collection of technical information dealing with broadcast problems. It has been prepared in a readily usable form. Loose-leaf arrangement has been provided for this handbook so that additional data may be incorporated from time to time.

Section A of this handbook has nine pages of text dealing with the subject of wave propagation. In addition, twelve full-page charts are provided on this subject. Day propagation and night propagation of waves for both low frequencies and high frequencies are included.

Section B also deals with the subject of wave propagation and more particularly with Rolf's graphs for ground-

wave propagation. Attenuation curves, derived from Rolf's graphs, are given in the first seventeen charts. These are for values of  $\epsilon$  (dielectric constant of the earth in electrostatic units) from 5 to 20 inclusive and for  $\epsilon = 81$  (sea water). These curves are applicable to any frequency within the range ordinarily used for medium-frequency or low-frequency broadcasting. The earth-curvature correction factor is indicated in the eighteenth chart. Also several families of curves representing ground-wave field intensities at various distances for various frequencies are given in the remaining seven charts.

Next is a general section on wave propagation and consists of a chart of radiation angle versus distance at which sky wave returns to earth (single reflection).

Other sections are devoted to non-directional antennas, transmission lines, directional antenna arrays, pads and attenuators, and FCC empirical standards and rules and regulations, the last three sections being quite comprehensive in scope.

The "NAB Engineering Handbook" provides data on which little authoritative collected information has previously been available in a readily usable form. The information was originated or compiled by James C. McNary, Technical Director of the NAB, who deserves commendation for this work.

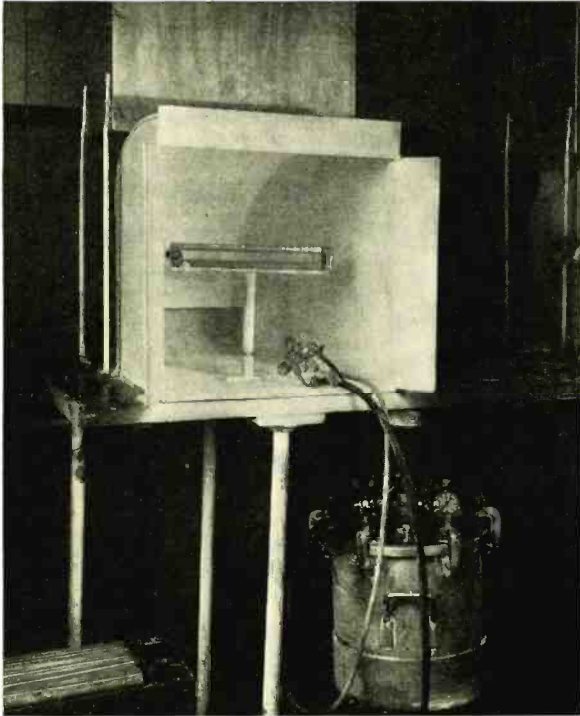

FIG. 1. SPRAY BOOTH WITH GUN AND AGITATOR FORMERLY USED FOR SPRAYING CATHODES AND REVERSE COIL HEATERS. AS SHOWN, IT IS SET UP FOR CATHODES.

## INDIRECTLY-HEATED

by G. D. O'NEILL\*

---

### *The History of the Development*

---

IN THE EIGHT OR NINE years that have elapsed since the introduction on a large scale of radio receiving tubes using indirectly-heated cathodes, there has been an evolution of the cathode which, while less spectacular than the development of the tubes themselves, is nevertheless remarkable.

This development has proceeded along three nearly independent lines:

(a) The improvement in ceramic insulators.

(b) The development of "quick heaters."

(c) Improvements in the technique of coating the cathode.

The difficulties encountered in making types 24 and 27 with the ceramic insulators available six to seven years ago now seem almost unbelievable. A piece of ceramic material, slightly smaller than the inside diameter of the nickel cathode, or sleeve, was used. There were two holes parallel to the axis through which was strung the

tungsten heater. The ceramic was mainly a sintered talc, or talc and magnesia mixture, and the tendency to melt during the exhausting of the tubes, especially the 24's, was all too pronounced. The ceramic frequently fused to the heater during operation in such manner as to pull the latter apart when it had become heated, and upon cooling contact was re-established, thus giving an intermittent heating and cooling. Some tube manufacturers used fused silica; reports as to its relative merits varied, but none was enthusiastic. Experience indicated that a reaction took place, eroding the tungsten heater.

Before this type of heater construction was finally abandoned in favor of the quicker heating types it had undergone considerable improvement. This was apparently brought about mainly through eliminating the talc and using nearly pure magnesia fired at higher temperatures. A further improvement was realized in substituting alundum for

the magnesia, for the reason that the former appeared to be less affected by impurities in the materials and did not give the mirror deposit of magnesium on the top of the bulb due, presumably, to electrolytic decomposition of the ceramic.

Improvements in the refractory properties of ceramic insulators were usually accompanied by increased mechanical strength. This made possible a reduction in mass with consequent shortening of the time required to bring the cathode to operating temperature.

\*Hygrade Sylvania Corp.

# CATHODES

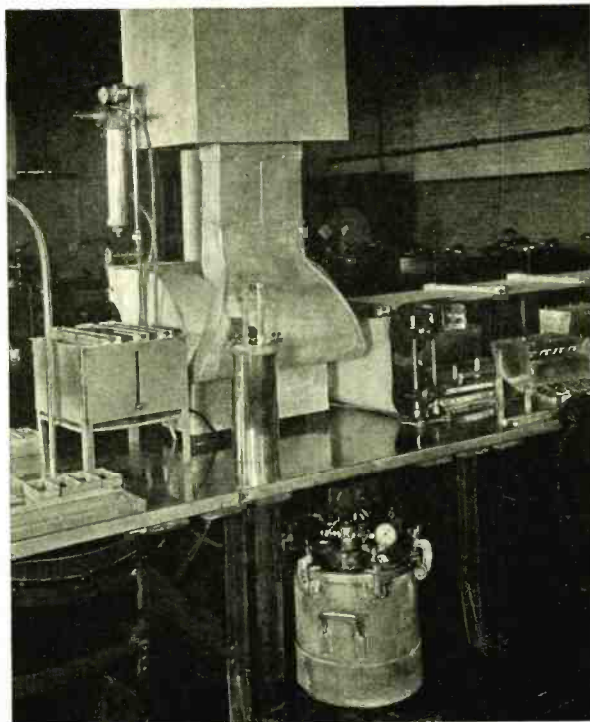

FIG. 4. VIEW OF AUTOMATIC COATING EQUIPMENT SHOWING AGITATOR, FRAME CLEANER, DRIER AND CATHODE BINS.

---

## *and Technique of Manufacture*

---

Such insulators were made in the form of a cylinder with two holes parallel to the axis for the heater, with the addition of grooves along the surface or deep cuts from the side. Other widely used designs included insulators of rectangular cross-section with a minimum of material between the heater holes and the outer edge of the insulator, and the thin-wall, single-hole insulator, one of the latter being used on each leg of the inverted V filament.

While the development of the pre-formed ceramic insulator was in progress, many attempts were made to replace it with an insulating coating ap-

plied directly to the heater. Of these attempts, the successful ones proceeded along two different lines and culminated in the two principal designs used at the present time.

So far as the writer is aware, the first of the two heaters to be described was used in the type 27 in 1927 by one manufacturer with considerable success. This heater was made by coating the heater wire in long lengths with aluminum bound to the wire with a suitable binding agent. Upon heating, the binding agent broke down to the oxide, still retaining its binding properties. The wire was then cut to length and shaped.

The reverse coil heater has proved to be very satisfactory and is largely used in tubes operated at 2.5 volts. The "non-inductive" winding keeps hum at a low value and heating time is reasonably short. The winding of this coil can be visualized by cutting a notch in the end of a pencil and inserting the middle of a string in the notch, the string being

held in a straight line. The pencil is then revolved on its axis and moved forward while the string slips through the fingers, one end going between the index and middle fingers, the other end through the thumb and ring finger. The machines used for making the coil operate on the same principle. The first reverse coil winding machines were hand-operated, the wire being wound on a steel mandrel notched at the end. The present machines in use are similar in principle, but power driven and entirely automatic in operation.

The coils, after winding, are cleaned and placed in holders for coating with ceramic material consisting essentially of aluminum suspended in amyl acetate or like solvent with a small percentage of nitrocellulose. Formerly a ceramic rod or post was inserted in the coil from the bottom to prevent short circuiting of the turns. Improved technique is rapidly bringing about the elimination of the post with consequent shortening of

heating time and other advantages.

The coating of the heaters is usually accomplished by spraying with the aluminum suspension in a hood as shown in Fig. 1, which in the photograph is set up for spraying cathodes.

The introduction of tubes operating at 6.3 volts, with their necessarily longer heaters, brought new problems in heater making which at first appeared to be more serious than subsequent improvement in technique proved. The first 38s (indirectly heated pentode output tube for auto sets) were made with a heater wound as a single-layer helical

tended to other types where the heater voltage is 6.3 or more, such as the 42, 43, 48, 25Z5, etc., in which cases the heater is necessarily a fairly long piece of wire.

The coating of this heater is done in a manner nearly identical to that used in coating nickel filaments with barium and strontium carbonates. The equipment used is shown in Fig. 2, where the first three and farthest lines of furnaces are used for heater coating while the fourth and fifth are used for coating nickel filaments. On the nearest side of the front bench the tungsten wire is

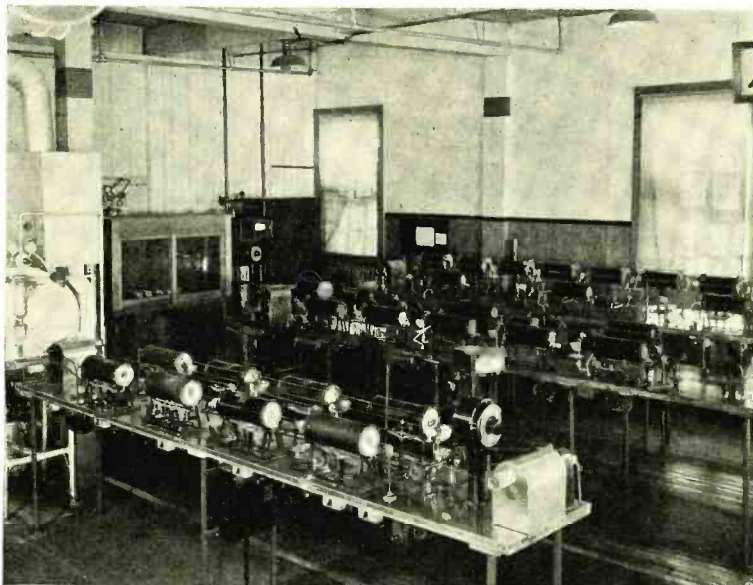

FIG. 2. EQUIPMENT USED FOR CONTINUOUS COATING OF HEATER WIRE AND NICKEL FILAMENT.

coil with the ends of the wire at opposite ends of the heater. This was quite unsatisfactory and some manufacturers changed to the old style ceramic heater with four holes for the four lengths of filament inserted into it, with the ceramic designed for minimum mass. One solution was the use of tungsten wire coated by a continuous process with aluminum; the wire was cut to size and bent into the form of an "M" and then slipped into the cathode. This design became known as the "M" heater or "folded heater." It proved to be very advantageous from the standpoints of quick heating and satisfactory manufacturing control, and its use has been ex-

unreeled from the left end and passes over a small wheel in a cup of aluminum suspension, where it picks up a small amount of the material, then through the electric furnace. Four cups and furnaces in all are used, and the wire is spooled at the near end of the bench. On one end of the bench will be noticed, in the photograph, a pyrometer with selector switch for connecting with any furnace on the bench. Rheostats for each furnace are mounted under the bench.

Early methods of coating the cathodes with materials which, upon heating, would break down to barium and strontium oxides were extremely crude; the

first production-made tubes had cathodes coated individually by hand. A number of processes were used, some of which will be mentioned briefly.

One process involved heating the cathode in a reducing atmosphere and holding against it a pencil of paraffin wax containing barium and strontium oxides while the cathode was revolving on a mandrel. Subsequent heating removed the wax.

Another process involved spinning the cathode on a mandrel and coating it with a paste of barium and strontium tungstates applied with a spatula.

A third, and more widely-used process, was that of applying with a camel hair brush, or with a forked wire, the barium and strontium carbonates suspended in an aqueous solution of barium nitrate.

Various kinds of activators, now generally abandoned, were used such as carbon black, oxalates, silver, barium azide, etc.

Fig. 1 shows an arrangement used by the Hygrade Sylvania Corporation for several years, and is typical of those used elsewhere. The container with a gauge below the table is a reservoir of barium and strontium carbonates suspended in organic solvents, principally amyl acetate, with a small amount of gun cotton to act as a temporary binder. The material in the reservoir is kept agitated by paddles operated by a motor. The hood on the table has an outlet low at the rear which is connected to a central exhaust system. In the center of the hood will be seen the frame holding fifty cathodes for spraying. The frame fits tightly together with the ends of the cathodes in grooves in order to keep the length of the coated band uniform and the ends clean. The gun, shown resting on the bottom of the hood, is similar to that used by painters. The spray material is drawn through one hose from the agitator, while the other hose connects to the air line. The hood on the end of the table is seen at the extreme left of Fig. 2; the cylindrical fixture with dial gauges is an arrangement for cleaning the air and regulating the pressure.

In operation, the gun is held at the level of the cathode frames and at an angle of approximately 45 degrees to the plane of the frame and moved at a uniform rate of speed past the length of the frame. At the completion of the stroke the gun is turned 90 degrees and a second stroke or pass is made. The frame is then turned around and the operation repeated. Thus the cathodes are sprayed from four directions separated 90°. An experienced operator can produce surprisingly uniform results by this method, although at best the human element of uncertainty still prevails. The

cathodes, after coating, are left in the frames for about a minute to dry in air over an electric heater and then removed to trays, ready to have the heaters inserted.

The natural limitations of the above described method of coating cathodes were recognized at an early date. By 1929, automatic spray machines were in operation which have since been discarded. In operation the cathodes were dropped on to mandrels which rotated as they passed the spray gun. Following the spraying the cathodes passed a position for drying by a current of warm air and were then removed. The rate of production and quality of coating were both surpassed by improvements in the hand spray method already described.

An improved mechanical coating machine is one designed to take advantage of the desirable features of hand spraying while at the same time reducing to a minimum the lack of uniformity due to the human element. This principle is embodied in the machine shown near the center of the photograph, Fig. 3, with auxiliary equipment on each side.

The table at the left of the spray machine has a wide conveyor belt moving toward the machine above the table and returning from the machine directly on the table. Operators who fill the spray frames sit at the table with a supply of bare cathodes in the small bins shown in the photograph. When filled, the frames are placed on the belt conveyor and brought to the spray operator, who places them on the machine as shown. Spraying is started by stepping on a pedal below the machine which engages a clutch.

The spray material is supplied to the gun from an agitator below the table, seen in Fig. 4, which is the same equipment shown in Fig. 3, but viewed from the rear. The air cleaner and regulator is shown attached to the hood over the spray machine. Upon completing the spray cycle the frame is lifted from the holder in front of the gun and laid on the drying box to the right, the box being merely a frame around an electric space heater with a grid on top, seen best in Fig. 4. Operators on both sides of the table take the frames from the drying box and remove the cathodes to trays. The frames are then dipped in the cylindrical cleaner directly in back of the spray hood and returned to the operators for filling via the conveyor. The cleaner is filled with amyl acetate and contains brushes; in operation it recalls the familiar golf-ball cleaner.

Referring again to Fig. 3, a torsion balance and notebook are seen at the extreme right. Sample cathodes are weighed, cleaned, and weighed again, complete records of coating weights being kept. Any frame of cathodes being

outside specified limits is rejected. A binocular microscope is used for frequent examination of samples for coating texture, being of especial value in adjusting the gun. The coated diameter of the cathodes is checked using a machinist's microscope; the results, with weights of coating, being used to check coating density.

Comparing costs of producing a type 24A tube in 1936 with the cost of producing the type 24 in 1929 does not give a true figure as to the difference due to the improvement in cathode and

of lowered manufacturing costs.

The frequency of necessary replacements is undoubtedly reduced to half; in other words, the average life is at least doubled.

The uniformity of tubes is much greater, manufacturing and testing tolerances are more rigid, made possible largely because of increased uniformity of cathode performance. The difficulty of not securing performance with a replacement tube equal to that obtained from the original has been eliminated.

Probably the most important result

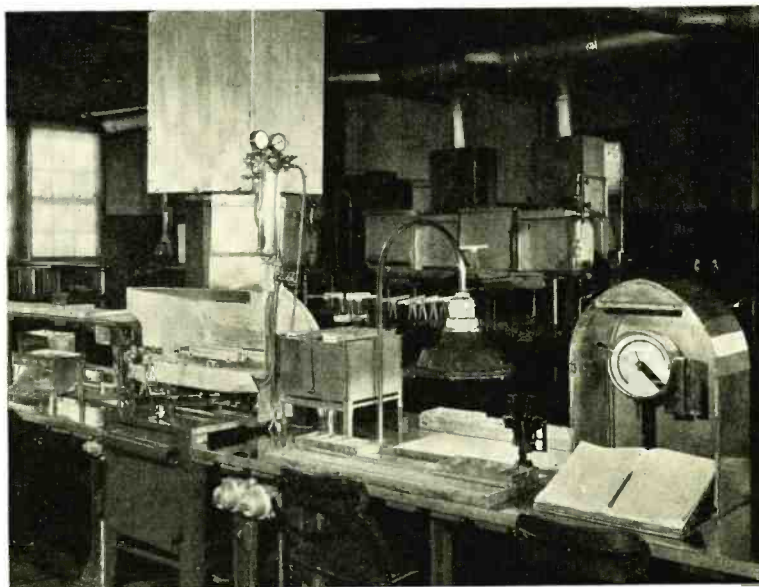

FIG. 3. COMPLETE SET-UP FOR COATING CATHODES BY AUTOMATICALLY OPERATED COATING MACHINE. LOADING OF THE FRAMES IS DONE ON THE LEFT, UNLOADING AND CHECKING ON THE RIGHT.

heater. Some parts cost more now, while the majority cost less; improvements in other processes have also lowered costs. However, considering the difference in cost between the complete cathode and heater at the two dates, and the difference in cost of factory shrinkage resulting from improvements in the heater and cathode, a fairly conservative estimate would be a reduction of 50% in manufacturing cost in five years. This saving, as in other manufacturing lines, is passed on to the consumer. It should be stated, however, that the reduction in list price from \$4.00 to \$1.00 is not all the direct result

of the technical improvements made in indirectly heated cathodes is that they have made possible many of the newer types of tubes which combine the functions of more than one tube or operate at heater voltages considerably above 2.5. If we had been called upon to make such tubes as the 43, 48 and 25Z5 with the solid ceramic insulators commonly used in 1927 or 1928, it would have been impossible to do so. To have attempted to make some of the newer types more within the bounds of possibility, such as the 78, 6F7 and 75, would, under the same limitations, have been a nearly hopeless undertaking.

# POWER AMPLIFIER DESIGN

by PAUL ADORJAN\*

BEFORE DEALING WITH design data on a particular type of push-pull power amplifier, it is necessary to define the different types. Various definitions have been published in this connection and it is not intended to introduce any new name here, but to use the most generally adopted nomenclature.

**Class A Amplifier.** Push-pull amplifier with tubes biased to middle of the straight part of the grid volts-plate current characteristic. See Fig. 1 (a). No grid current is allowed to flow. The angle of operation of each tube is  $360^\circ$ .

**Class A Quiescent or Class AQ Amplifier.** The tubes are biased nearer the "bottom bend" of the grid volts-plate current characteristic. No grid current is allowed to flow. See Fig. 1 (b). Angle of operation of each tube is between  $180^\circ$  and  $360^\circ$ .

**Class AB Amplifier.** Similar to Class AQ, but tube is driven into the positive grid region, allowing the flow of grid current. See Fig. 1 (c). The angle of operation of each tube is between  $180^\circ$  and  $360^\circ$ .

**Class B Amplifier.** Only suitable for use with special tubes in which plate current is approximately zero with zero grid bias. This type of equipment is normally used with approximately zero grid bias and therefore grid current flows immediately a signal is applied. See Fig. 1 (d). The angle of operation of each tube is  $180^\circ$  or just over.

**Class C Amplifier.** With this type of amplifier the tubes are biased below the cut-off value of the grid volts-plate current characteristic. The angle of operation of each tube is less than  $180^\circ$ . (Not suitable for audio-frequency amplification). See Fig. 1 (e).

Fig. 2 shows typical characteristic curves for a tube used for Class AB operation. The circuit used to obtain these characteristics is shown in Fig. 3. The curves shown on Fig. 2 represent the plate current and grid current as measured, output watts ( $I_a^2 R$ ), plate resistance ( $\frac{V}{I_a} - R$ ) and plate dissipation ( $I_a^2 \times R_a$ ). Similar characteristics to these may be obtained with the various class B and class AB tubes.

Such characteristics as these will greatly assist the designer as practically all the information that is required is forthcoming from them. The voltages, currents and powers referred to in Fig. 2 are steady current values which are equivalent to instantaneous values of alternating current. They will be referred to as instantaneous values hereafter. The grid resistance and the total grid voltage that is required to obtain a certain output are given by these curves, and thus the grid input power that is to be delivered by the driver stage can be calculated. The peak plate current values are also available and with the help of the plate loss curve, the designer can see whether the tube will be running within its rated dissipation. It should be noted that the plate dissipation and output watt figures refer to instantaneous values. It will, therefore, be necessary to divide the instantaneous output watt figures by 2 to obtain rms output watts, and allowance will have to be made for output transformer efficiency.

A number of similar sets of curves can be obtained using various values of  $R$  in Fig. 3.

The output transformer primaries should be designed to work from a resistance of  $4R$  when using two tubes in

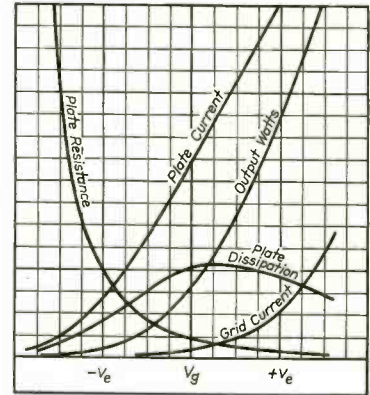

Fig. 2.

a class B or class AB push-pull arrangement. In the case of class AB push-pull amplifiers, the plate loss in the negative grid region should, strictly speaking, be calculated to allow for varying load resistance, but it has been found that this is of no great importance and it will not be dealt with in this paper.

Harmonic distortion figures can be calculated from the plate current-grid voltage characteristics using various methods, for instance, the short-cut method described by I. E. Mourmousteff and H. N. Kozanowski in the Proceedings of the Institute of Radio Engineers, September, 1934.

It will be seen from Fig. 2 that the instantaneous plate dissipation reaches a maximum value and this maximum value can be expressed in terms of the plate voltage and load resistance if the instantaneous plate dissipation is differentiated with respect to the instantaneous plate current.

\*Technical Director, Rediffusion, Ltd., London.

Fig. 1.

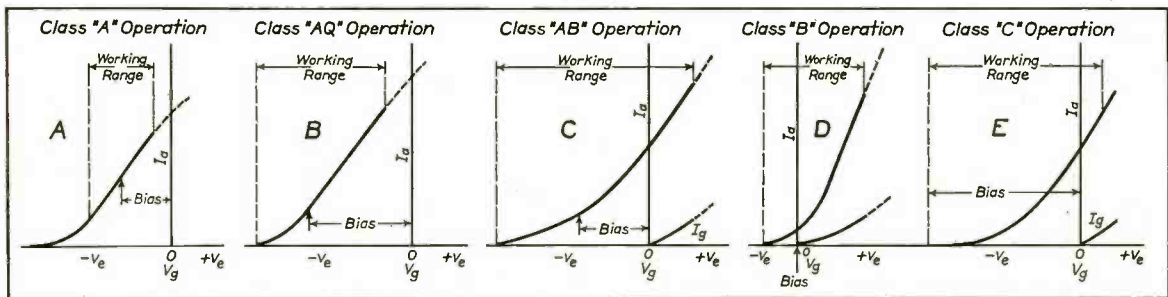

$$W_a = I_a^2 R_a \dots\dots\dots (1)$$

$$R_a = \frac{V}{I_a} - R \dots\dots\dots (2)$$

$$W_a = I_a V - I_a^2 R \dots\dots\dots (3)$$

$$\frac{dW_a}{dI_a} = V - 2I_a R \dots\dots\dots (4)$$

for maximum where  $\frac{dW_a}{dI_a} = 0 \dots\dots (5)$

$$2I_a R = V \dots\dots\dots (6)$$

(and  $R_a = R$ )

$$\therefore W_a (\text{peak}) = \frac{V^2}{4R} \dots\dots\dots (7)$$

$$R = \frac{V^2}{4W_a (\text{peak})} \dots\dots\dots (8)$$

where  $I_a$  = plate current  
 $R_a$  = plate resistance  
 $V$  = plate volts  
 $R$  = load resistance.

Equation (8) gives the minimum value of R that can be employed for a particular peak dissipation and plate voltage.

The makers rating usually refers to

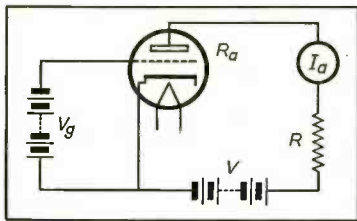

Fig. 3.

the plate dissipation averaged over any audio-frequency cycle. The relation between peak plate dissipation and average plate dissipation varies largely, depending upon the operating conditions and characteristics of the tubes concerned, but as a rough rule, if the steady current on the tube does not exceed half of the plate current at the instant of maximum plate dissipation, it is safe to allow a peak dissipation of 1.5 times the average plate dissipation.

*Example.* Tube to be operated at 1,000 volts plate with small steady current. Rated average plate dissipation—100 watts. Estimated safe peak plate dissipation—150 watts (see above). Minimum permissible load resistance  $1000^2$   
 $\frac{1000^2}{150} = 1670$  ohms, per tube, or 6680  $4 \times 150$  ohms plate to plate load for two tubes.

Fig. 4 shows curves of minimum load impedance per tube against peak plate dissipation for various plate voltages.

Consideration of the foregoing enables us to estimate the maximum power

output that can be expected from tubes of this type.

The limit to which output tubes can be driven is determined by the ratio of the minimum instantaneous voltage on the plate to the peak positive grid voltage. It is obvious that if the grid becomes more positive than the plate it will in fact act as a plate and consequently very heavy grid current will flow. Distortion will be caused due to loading of the driver stage and also non-linearity due to "bending over" of the grid voltage-plate current characteristic. If the ratio of peak positive grid volts divided by instantaneous minimum plate voltage is expressed as k, under peak drive conditions—

$$V - I_a R = \frac{V}{\mu k} \dots\dots\dots (9)$$

where  $\mu$  is greater than 1. (Amplification factor of tube assumed to be constant over the working range.)

$$I_a = \left( \frac{V\mu k - V}{\mu k R} \right) \dots\dots\dots (10)$$

$$I_a^2 R = \left( \frac{V\mu k - V}{\mu k R} \right)^2 R \dots\dots\dots (11)$$

$$= \left( \frac{V\mu k - V}{\mu k} \right)^2 \frac{1}{R} \dots\dots\dots (12)$$

Substitute (8) for R

$$I_a^2 R = \frac{4W_a}{V^2} \left( \frac{V\mu k - V}{\mu k} \right)^2 =$$

$$4W_a \left( 1 - \frac{1}{\mu k} \right)^2 \dots\dots\dots (13)$$

The value of k varies in practice, but can be estimated as about .7 max.

Graphs are plotted on Fig. 5 based on (13) showing output watts against plate dissipation for various values of  $\mu k$ .

It should be noted that if peak plate dissipation values are taken, peak output watts are obtained. (This divided by 2 will give rms output watts.)

The results obtained by the use of (13) will give the maximum power output that can be obtained without over-running the tube. The amount of harmonic distortion which will be present will depend on the curvature of the grid voltage-plate current characteristic, and in order to keep this distortion within the permissible limits, it may be necessary to increase the load resistance R and/or reduce the value of k, resulting in departure from maximum efficiency from the point of view of transfer of power.

**Editor's Note**

In connection with the above material, the following data which were taken from an unpublished IRE paper

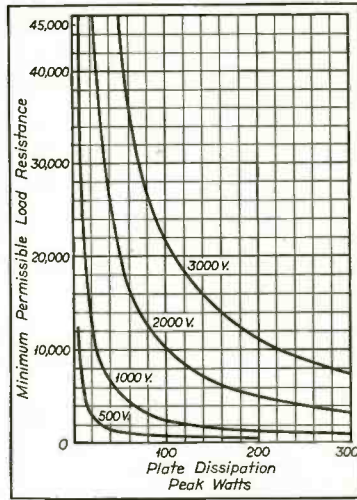

Fig. 4.

by L. E. Barton, RCA Mfg. Co., Camden, N. J., should be of interest: The theoretical considerations for the driver systems for class B audio- or radio-frequency amplifiers and the experimental values which substantiate the accuracy of the theory indicate that a low impedance driver system is very important for low distortion class B systems.

Another important consideration... is the plate current characteristic of the tube. This characteristic should be such that the disturbance in the output wave near the zero axis of plate current may be as low as possible. Practically, this result can best be obtained by purposely causing the plate current to tail-off appreciably, which results in appreciable no-signal plate current. The remote plate current cut-off is particularly helpful in reducing distortion when high plate resistance tubes are used as class B audio amplifiers.

The class B amplifier plate load is somewhat critical for maximum power output and minimum distortion.

Fig. 5.

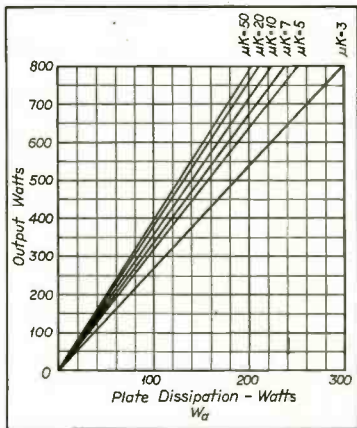

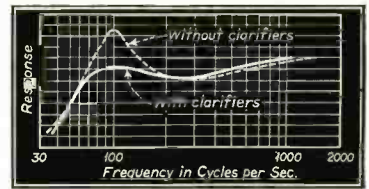
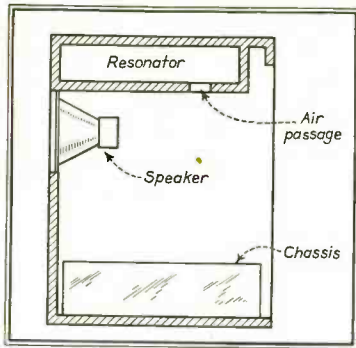

Above: Fig. 3. The response characteristic of the Philco Model 680X receiver.

Left: Fig. 1. A Helmholtz resonator similar to the type used in the RCA R-78.

# IMPROVING LOW-FREQUENCY RESPONSE

by R. D. RETTENMEYER

Editor, COMMUNICATION AND BROADCAST ENGINEERING

## *A Resume of the Methods That Have Been Developed for Improvement of Low-Frequency Response, with Particular Emphasis on the Reduction of Cabinet Resonance Effects*

ONE OF THE bugbears to high-fidelity reception has been inadequate low-frequency response. It is practically impossible to incorporate sufficient baffle area in a radio cabinet to permit adequate low-frequency reproduction, since a baffle some eleven feet square is actually required for a cutoff of fifty cycles.

In attempting to create the illusion of low-frequency response, design engineers have frequently overcompensated the receiver by peaking the loudspeaker at about 100 cycles. This has resulted in the familiar boomy reproduction which is so disagreeable when the human voice is reproduced. Further, in the large console units, cabinet resonance often occurs at about this frequency augmenting the already over-emphasized response near 100 cycles. This effect is particularly vicious when an open-back cabinet is placed only a few inches from the wall.

It is the purpose of this article to outline some of the arrangements devised for increasing acoustic response below 100 cycles and for overcoming cabinet resonance.

It has often been emphasized that the conventional direct-radiator-type dynamic loudspeaker will not give low-

frequency reproduction without some sort of a baffle. At the lower frequencies the cone moves in piston fashion so that with each forward movement of the cone the air is compressed in front of the unit and rarefied at the back. On the return motion the opposite effect occurs, and if no baffle is provided air will flow from the compressed region to the rarefied one. Since the wavelengths for these frequencies are comparatively long, this movement of the air will not result in the radiation of appreciable low-frequency power.

While a large cabinet does permit the generation of low-frequency sound waves it also helps to introduce cabinet resonance. The acoustic system of a radio receiver, consisting of cabinet, cone and open back is similar to an open pipe, and according to Massa and Olson<sup>1</sup> resonance occurs when the ratio of the velocity of the cone, or the air in the opening in the back, to the applied force is a maximum. At this fre-

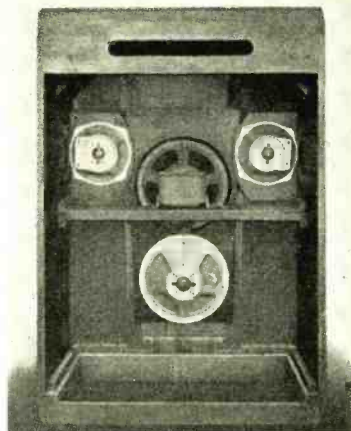

Fig. 2. The Acoustic Clarifiers used in the Philco Model 680X resemble speaker diaphragms.

<sup>1</sup>Chapter 7, *Applied Acoustics*, by Olson and Massa.



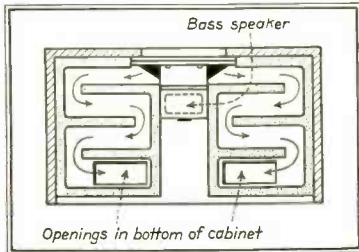

Fig. 4. The Stromberg-Carlson Acoustical Labyrinth.

quency maximum energy will be radiated not only from the cone but also from the back of the cabinet.

The usual procedure in dealing with cabinet resonance has been to provide a form of air path between the region in front of the cabinet near the loudspeaker and the outside air. This is done in order to release the pressure and reduce the building-up tendency at the resonance frequency. If this path has an acoustic impedance that is low enough to effectively reduce the pressure, it will also allow sufficient air circulation to reduce the low-frequency response. By making use of a properly designed Helmholtz resonator this pressure can be reduced at the resonance frequency and at the same time the low-frequency response can be retained. As a matter of fact this device was used in the RCA Victor Model R-78 receiver produced several years ago. The Helmholtz resonator in this model consisted essentially of an air chamber having a small opening coupling it with the air inside the cabinet as shown in Fig. 1. The air within the chamber is compressed and expanded by the motion of the air in the opening and thus serves to reduce the pressure at the resonance frequency.

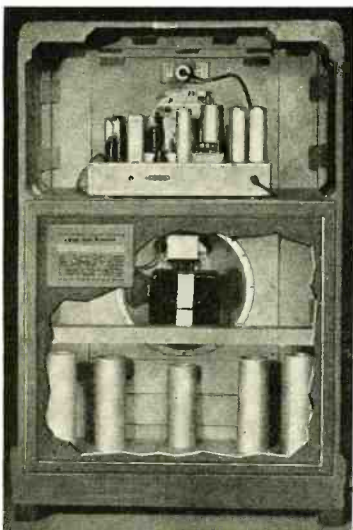

Fig. 6. The acoustic system used in the new RCA receivers.

Acoustic Clarifiers which absorb the bass notes rebounding from the wall back of the receiver or from the receiver sides are featured in the Philco Model 680X. These clarifiers, as may be seen from Fig. 2, resemble speaker diaphragms but are connected to resilient material. Fig. 3 shows a typical frequency-response curve for this unit. The recently announced Philco Model 690X uses four of these clarifiers.

In the Stromberg-Carlson Series 70 receivers is found another unique method for reducing cabinet resonance and also increasing the low-frequency response. These receivers employ what is known as an Acoustical Labyrinth. The Acoustical-Labyrinth system prevents the sound coming from the back of the loudspeaker from being discharged into the interior of the cabinet. This is accomplished by the application of a housing around the rear of the low-frequency speaker. This housing communicates with the free air through a passage lined with a material having a high value of acoustic absorption.

The type of labyrinth shown in Fig. 4 consists of two separate units symmetrically connected to the openings at the rear of the loudspeaker with the other ends of the conduits discharging through the openings located in the bottom and at the back of the cabinet. This provides a balanced acoustical load to the back of the speaker cone and prevents uneven action that might drive it out of line.

For a given size of baffle area, the Acoustical Labyrinth can be proportioned so as to reinforce the low-frequency response just below the natural cutoff due to baffle limitation. The correct design of the shape of the conduit, the orifice of the shape of the conduit, and the absorbing materials employed results in a low-frequency response that is smooth and free from distortion peaks as may be seen from the response characteristic of Fig. 5.

Another interesting device for increasing the response at lower frequencies is featured in the recently announced RCA receivers. This device, known as the "Magic Voice," is shown in Fig. 6. It consists of a speaker unit mounted in a closed cabinet. Both sides of the diaphragm are utilized. The air displacement from the back of the diaphragm is shifted approximately 180° in phase and led out the bottom of the cabinet. The volume of air in the chamber and the mass of air in the outlet passages result in the desired acoustic stiffness and mass. The air in the passages and the volume velocity of the diaphragm are so related in phase as to resemble a low-pass filter in which the current in the two series arms is approximately 180° out of phase above

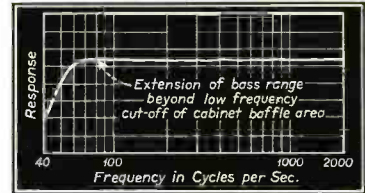

Fig. 5. The response characteristic obtainable from an Acoustical Labyrinth.

the cutoff frequency of the filter. The power output of this acoustic system, however, is considerably different from its electrical counterpart, the low-pass filter, since the air mass and the radiation resistance of the passages, and the radiation resistance and air mass of the diaphragm have a mutual reaction on each other.

In Fig. 7 is shown a typical frequency-response characteristic for this type of acoustic system. The full line indicates the sound output that may be expected when the speaker is operated with open back and no tubes, while the dotted curve shows the sound output with the back closed and the tubes in place. If it is desirable to avoid any noticeable peaks near the cutoff, the tubes may be lined with an acoustical absorbing material to introduce acoustic resistance.

No attempt has been made to completely cover the field of acoustic systems affecting low-frequency response. Rather it has been the purpose to point out some of the more interesting arrangements now being used with the thought of indicating the trend of engineering design in this field. It appears to be high time that engineering ingenuity and effort be directed to cleaning up the low-frequency response of those receivers having some claim to high fidelity. While high-frequency response has its value as well as its limitations in broadcast receivers, it is the writer's opinion that adding an octave or so of reasonably smooth low-frequency response is equally important. Moreover, it seems certain that such effort is likely to be rewarded with some appreciation by the prospective purchaser. It is predicted that this field will be more thoroughly investigated in the near future.

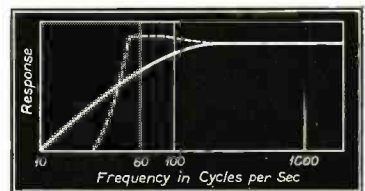

Fig. 7. A typical response characteristic for the type of acoustic system shown in Fig. 6.

# OIL CONDENSER CHARACTERISTICS\*

*Set Manufacturers Are Showing Interest in Oil Dielectric Condensers. Some Pertinent Factors Are Discussed Below.*

WHILE OIL-IMPREGNATED paper is old in the art, the special properties of this type of insulation have only recently been generally understood. The effect of modifying several variables which go into the manufacture of oil-impregnated insulation will be taken up in detail. However, the final result of the possible modifications is best shown by means of a curve of life *vs.* voltage.

## Life vs. Voltage

The accompanying curve, Fig. 1, shows life *vs.* voltage for condensers rated 220 volts, 330 volts, and 440 volts, for applications at 60 cycles.

The quality of the condenser is determined by the shape of the life test curve. The figure indicates that the curves on semi-logarithmic paper flatten out to a steady voltage at long life. The theoretical voltage at which infinite life may be expected can be calculated from the curves using a formula given by

\*Data furnished by Sprague Specialties Co.

Peek which involves a fourth power relation. This equation is somewhat conservative, and the actual infinite life voltage is somewhat higher than that given by the formula.

The voltage for infinite life may be obtained graphically. When the life data is plotted on log-log paper, that is, log of voltage *vs.* log of life, the resulting curve is concave upwards. By subtracting the infinite life voltage from the ordinates, the concave-upward curve becomes a straight line. By means of such graphical calculation we find that the voltage for infinite life is about 250 volts a-c higher than the actual rated voltage.

## Viscosity of the Oil

An important consideration in oil-impregnated dielectrics is the quality of the impregnation. When the condenser is originally wound with alternate layers of papers and foil, the dielectric consists of paper, water (moisture) and

air. None of these three is a particularly good dielectric and a successful condenser depends upon:

- (1) Removal of all the moisture by vacuum drying.
- (2) Displacement of all the air by a dry oil.

Moisture is fairly easily removed by vacuum drying equipment, and its presence or absence is readily detected by measurement of the direct-current leakage resistance. The main effect of the moisture in the condenser is to raise the conductivity of the condenser, which increased conductivity permits electrolytic action to occur, leading to the failure of the condenser. If the direct-current leakage resistance is of the order of 1000 megohm-microfarads or higher at ordinary temperatures, then we can be fairly sure that no appreciable amount of moisture is present in the finished condenser. If the leakage resistance is much lower then it is quite probable that an appreciable amount of moisture is left in the condenser and its early failure may be expected.

Residual air bubbles left in the condenser are more difficult to detect, although their deleterious effects are very severe. At ordinary voltage gradients and temperatures, the presence of air does not apparently affect the electrical characteristics. As the voltage gradient is raised, however, ionization in the air spaces occurs which causes deterioration of oil and manifests itself by an increase in power factor. An air-free condenser will show power factor to be independent of the voltage gradient throughout a wide range, whereas when air is present, the power factor will be independent of voltage up to a critical voltage gradient corresponding to the ionization potential, and above this voltage gradient, the power factor rises rapidly.

(Continued on page 19)

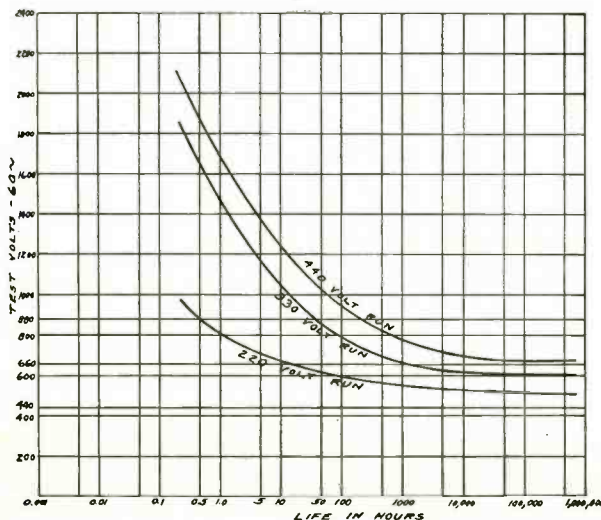
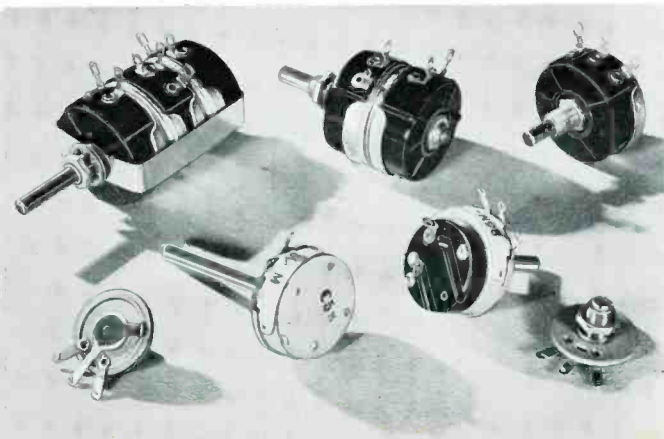
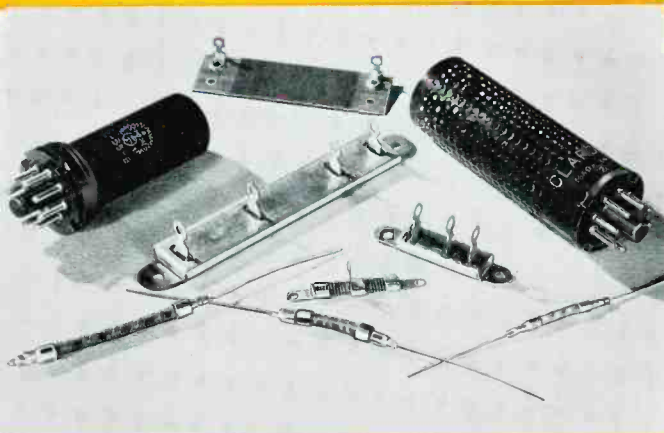

Fig. 1.

# Solutions to . . . RESISTANCE PROBLEMS



CLAROSTAT Adjustable Resistors



Fixed Resistors and (below) Ballasts

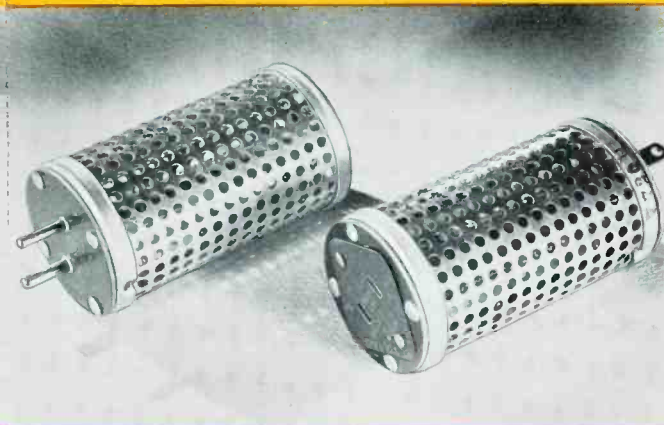

**T**HEY fade into insignificance, those resistance problems, if you just remember two things: First, call on the CLAROSTAT engineering staff to help you work out the best possible resistance means for that particular circuit. Second, depend on the CLAROSTAT factory to turn out any number of resistance units precisely matching the most rigid specifications.

## ★ ADJUSTABLE RESISTORS

**C**LAROSTAT potentiometers and rheostats are available in composition-element (widest resistance range and intricate tapers) and wire-wound (higher wattage) types. • In single, dual and triple units for various functions, including T-pad, mixer and L-pad constant impedance con-

trols. • Units may be had with or without power switches; clockwise or counter-clockwise; any length of shaft; etc. • Also inexpensive, compact "Humdingers" — handy little potentiometers, wire-wound, 1 to 1000 ohms—for hum control, sensitivity control, battery voltage control, etc.

## ★ FIXED RESISTORS

**I**NEXPENSIVE flexible resistors, wire-wound, braided cover, long pigtail leads. Popular in point-to-point wired assemblies. • Wire-wound strip resistors, bare and metal-clad. Also precision resistors

(wound to 1% tolerance or less). • Wire-wound plug-in and metal tube type resistors, for line voltage dropping and for resistance network purposes.

## ★ AUTOMATIC RESISTORS

**O**THERWISE known as ballasts and intended to increase resistance with rise in voltage, and decrease with falling voltage, thus maintaining constant voltage in given circuit. • Widely used in sections faced with fluctuating

line voltage, for the safe and uniform operation of radio sets, electronic devices and other delicate equipment. • Units available with any American or Continental type male and female terminals.

**Write . . . .** on your business letterhead for new loose-leaf technical specifications covering entire CLAROSTAT line of resistance devices. Meanwhile, do not hesitate to place your resistance problems before us for engineering aid and quotations.



# CLAROSTAT

MANUFACTURING CO., Inc.  
285 - 7 North Sixth Street  
BROOKLYN, N. Y.

Loss Due to Various Types of Attenuators

Loss in DB	a		c		* e		f		g		i		j	
	a w	b w	c w	d w	e w	f w	g w	h w	i w	j w	i w	j w	i w	j w
1	0.058	8.664	0.115	17.386	0.109	8.193	0.122	9.193	0.244	4.097	0.244	4.097	0.244	4.097
2	0.115	4.305	0.232	8.724	0.206	3.862	0.259	4.862	0.518	1.931	0.518	1.931	0.518	1.931
3	0.171	2.839	0.352	5.848	0.292	2.424	0.413	3.424	0.825	1.212	0.825	1.212	0.825	1.212
4	0.226	2.097	0.477	4.419	0.369	1.710	0.585	2.710	1.170	0.855	1.170	0.855	1.170	0.855
5	0.280	1.645	0.608	3.570	0.438	1.285	0.778	2.285	1.557	0.642	1.557	0.642	1.557	0.642
6	0.332	1.339	0.747	3.010	0.499	1.005	0.995	2.005	1.991	0.502	1.991	0.502	1.991	0.502
7	0.382	1.116	0.896	2.615	0.553	0.807	1.239	1.807	2.478	0.404	2.478	0.404	2.478	0.404
8	0.431	0.946	1.057	2.323	0.602	0.661	1.512	1.661	3.024	0.331	3.024	0.331	3.024	0.331
9	0.476	0.812	1.232	2.100	0.645	0.550	1.818	1.550	3.637	0.275	3.637	0.275	3.637	0.275
10	0.519	70,273 †	1.423	1.925	0.684	46,248 †	2.162	1.463	4.325	23,124.000 †	4.325	23,124.000 †	4.325	23,124.000 †
20	0.818	20,202 †	4.950	1.222	0.900	11,111 †	9.000	1.111	18.000	5,555.600 †	18.000	5,555.600 †	18.000	5,555.600 †
30	0.939	6,330.9 †	15.796	1.065	0.968	3,265.5 †	30.623	1.033	61.246	1,632.800 †	61.246	1,632.800 †	61.246	1,632.800 †
40	0.980	2,000.2 †	49.995	1.020	0.990	1,010.1 †	99.000	1.010	198.000	505.050 †	198.000	505.050 †	198.000	505.050 †
50	0.994	632.46 †	158.110	1.006	0.997	317.23 †	315.23	1.003	630.460	158.620 †	630.460	158.620 †	630.460	158.620 †
60	0.998	200.00 †	500.00	1.002	0.999	100.10 †	999.00	1.001	1,998.000	50.050 †	1,998.000	50.050 †	1,998.000	50.050 †
70	0.999	63.246 †	1581.10	1.000	0.997	31.633 †	3,161.3	1.000	6,322.600	15.816 †	6,322.600	15.816 †	6,322.600	15.816 †
80	1.000	20.000 †	5000	1.000	1.000	10.001 †	9,999.0	1.000	19,998.000	5.001 †	19,998.000	5.001 †	19,998.000	5.001 †
90	1.000	6.325 †	15,811	1.000	1.000	3.163 †	31,622	1.000	63,244.000	1.581 †	63,244.000	1.581 †	63,244.000	1.581 †
100	1.000	2.000 †	50,000	1.000	1.000	1.000 †	99,999	1.000	200,000	0.500 †	200,000	0.500 †	200,000	0.500 †

To determine the attenuation, multiply the values read from the chart by the impedance of the circuit into which the network is inserted.  
 \* The impedance of this network, in the direction of the arrow, is  $e^A$  ohms. † The impedance of this network, in the direction of the arrow, is  $e^A$  ohms; where  $e$  is the base of the natural system of logarithms and  $A = 0.115 X$  loss in db. These may be read from exponential tables.  
 ‡ These values have been multiplied by  $10^5$

Thus the displacement of all air from the condenser by the impregnating oil is absolutely essential. With the crude impregnating technique of the early art, however, in order to get a complete displacement of air it was necessary to use a very thin oil of low viscosity. While the thin oils in themselves have many disadvantages, these disadvantages were slight compared to the disadvantages resulting from a poor impregnation.

The confusion which has existed in the minds of early writers on this subject has led to some peculiar statements in the literature. For example, papers in the A. I. E. E. Transactions have described test results obtained by impregnating paper at 40° C. with high and low viscosity oil. The results shown are overwhelmingly in favor of the light oils and are probably accurate for impregnation processes carried out at 40° C. However, when the condensers are impregnated at higher temperatures, the results are of an entirely different order of magnitude. We find that if we impregnate oils not at the same temperatures, but at the temperatures at which their viscosities are the same, the results show overwhelmingly that at room temperature the more viscous oils have better life characteristics.

Fig. 2 shows a comparison of the life of oil-impregnated insulation:

- (a) with careful displacement of air by the impregnation process, and
- (b) with residual air left in.

This data is taken from the *Elektrotechnik und Maschinenbau*, Volume 51, 1933, page 30. Of particular interest in this curve is the fact that the unsatisfactory condenser at certain high voltages actually shows a longer life than does the well impregnated condenser. This normally is due to the fact that the air inclusion, while causing ionization which ultimately leads to the destruction of the condenser, does for a short time afford a somewhat better protection against breakdown.

In other words, the air dielectric is capable of standing high voltage without breakdown for a short time, while

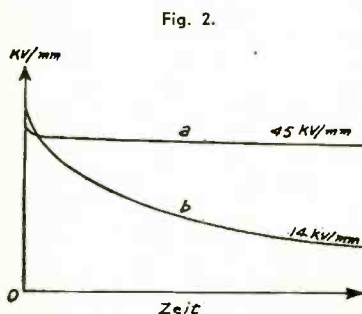

Fig. 2.

the ionization process which accompanies the high voltage is rather slow in making itself felt. The curve furnishes a splendid illustration of the fact that comparative tests on a condenser taken at a single high voltage are not only inconclusive, but also that they lead to entirely erroneous results. Referring back to the equation of Peek, it will be found that the life at two voltages must be known before the equation can be solved and the voltage of the condenser of infinite life determined.

#### Chemical Effects of the Oil

The chemical changes which occur in oil should be classified into those which occur in the presence of air and those occurring in the absence of air. Many of the changes which do occur in air are impossible of accomplishment in the sealed condenser where air is practically excluded.

For example, the combustion of the oil is a chemical change which occurs only in the presence of air and cannot possibly take place in a sealed condenser as long as the condenser remains sealed. Due to the fact, however, that condensers are alternately heated and cooled in operation we may expect that sooner or later there will be some access of air to the condenser. (This air from outside must be distinguished from air which is left in the dielectric interspace, as causing two entirely different phenomena.) The air is soluble in oil at atmospheric pressure, and this solubility increases with increasing pressure.

In a condenser fresh from vacuum impregnation, subjected to atmospheric pressure, the residual air left in the condenser is that amount of air which is in excess of the solubility of air in oil at atmospheric pressure. In the well impregnated condenser there is rather less air left in the condenser than would satisfy this solubility requirement, and air from the outside will dissolve in the oil to an amount determined by the solubility.

These chemical changes which occur in the oil or in the absence of air are those caused by the electric field. The electric field affects chemical reactions in very nearly the same way that a higher temperature affects them, namely, it accelerates them. A light transformer oil in a strong electric field and in the absence of air changes with a formation of a hard insoluble wax, and simultaneously of hydrogen gas. The hydrogen gas liberated in the dielectric will cause ionization at high voltage gradients and consequently, deterioration in much the same manner as will air. With the viscous heavy oil, this formation of wax and hydrogen is not found to take place.

This relative behavior of the light

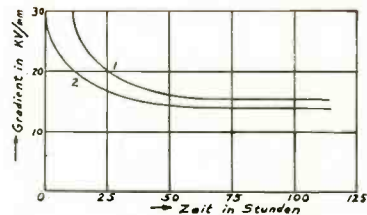

Fig. 3.

transformer oil and the heavy viscous oil is related to the behavior of these oils at high temperatures. At high temperatures hydrocarbons undergo a process variously known as pyrolysis, or more familiarly "cracking," whereby hydrocarbons start to decompose according to a process which ultimately results in the formation of carbon and of hydrogen gas. It is well known that the heavy oils are resistant to cracking, or in other words, in order to obtain cracking with heavy oils, much higher temperatures are necessary.

While the temperatures of impregnation or operation of condensers are, for example, quite low compared to the temperatures of petroleum cracking stills, nevertheless the difference in behavior of the two types of oil can be detected at low temperatures. For example, at 110° C., the light transformer oils are already unstable and sufficient decomposition would take place during a normal impregnation cycle to make resulting condensers thoroughly unsatisfactory.

Thus for chemical stability in the absence of air both at high temperatures and at high voltage gradients, the use of heavy viscous oil is strongly indicated.

The chemical effects in the presence of air may be subdivided into:

- (a) acid formation,
- (b) sludge formation,
- (c) combustion.

The acid formation and sludging both occur as a result of an oxidation process. While here again the heavy viscous oils are inert as compared to the light transformer oils, nevertheless the effects of oxidation even in the viscous oil can be deferred if not entirely prevented by the use of suitable anti-oxidizing agents. These anti-oxidizing agents manifest themselves by absorbing any available oxygen into a stable chemical compound, which is not an acid or a sludge, and thus prevents the available oxygen from attacking the oil.

Fig. 3, taken from *Elektrotechnik*, Volume 53, February, 1932, page 146, shows in curve (1) the increased life which is obtained in dielectric through the addition of an anti-oxidant, curve (2) showing the life without the anti-oxidant, but still showing a fairly good life characteristic.

# CIRCUIT CONSIDERATIONS IN THE

by W. N. DURHAM\*

TECHNICAL DATA thus far published with reference to the 6L6 beam power tube, although complete in so far as the tube itself is concerned, does not include specific circuit requirements for obtaining maximum benefits from the new development.

Economy in parts and production cost—in watts per dollar—are among the most striking advantages offered by the 6L6. The published characteristics emphasize high power output, high power sensitivity, and low third and higher order harmonic content; features that will appeal particularly to the sales department. The designer, however, is more interested in watts per dollar.

The present article will be confined to features of this tube based upon no grid current operation in push-pull power stages.

From the point of view of the manufacturer and of the design engineer, all the many advantages of the 6L6 can

\*Consulting Sound Engineer, Wholesale Radio Service Co., Inc.

be referred to one or the other of these two factors:

1. Less exacting power supply requirements.
2. Simplification of input requirements.

They are discussed below in the order given.

More liberal requirements with reference to power supply are the source of the major economies afforded by use of the 6L6 tubes; smaller average variations of plate current are encountered in their operation. As a result, both the power source (power transformer) and the filter system can be modified to the advantage of the designer without in any way affecting the quality or reliability of operation, or the power output obtained in Class A or Class AB<sub>1</sub> circuits.

With reference to the power transformer, a much smaller unit can be used. Using a power transformer originally designed to afford 15 watts audio output with other tubes, 25 watts output

has been obtained with 6L6s—an increase of 66-2/3 percent in the power efficiency of the plate winding. Moreover, it has been found that a lesser degree of voltage regulation, and a plate winding of higher resistance (with consequent greater temperature rise) are wholly satisfactory. These changes involved no sacrifice of other standards, either of performance or of trouble-free operation.

In the matter of the filter system, the 6L6 makes it entirely feasible to use high-resistance chokes; and while it is not common practice to use series speaker fields as filter chokes in the design of p-a amplifiers, very important economic considerations make such arrangements necessary in radio receivers. The optimum power supply conditions for the 6L6 conform to those economic needs, whereas with tubes having wide excursions of plate current, the use of high-resistance speaker fields in the filter circuit seems entirely impracticable.

From the point of view of power supply costs, problems of control grid bias for the 6L6 do not differ materially from those encountered with other power tubes.

From the point of view of heater power supply, both the 6L6s and other tubes currently available require 10 watts heater power for equal audio output at equal harmonic content. Thus the 6L6 affords no advantage in the matter of heater requirements, but incorporates no disadvantage to offset the gains realized in the plate supply circuit.

Screen supply for the 6L6, however, presents special problems. Screen voltage must be approximately 100 volts lower than plate potential, but it cannot be obtained through a simple series resistor inasmuch as the screen excursions, although small in actual value, are large

Fig. 1. Circuit of Lafayette High-Fidelity Amplifier Using 6L6s

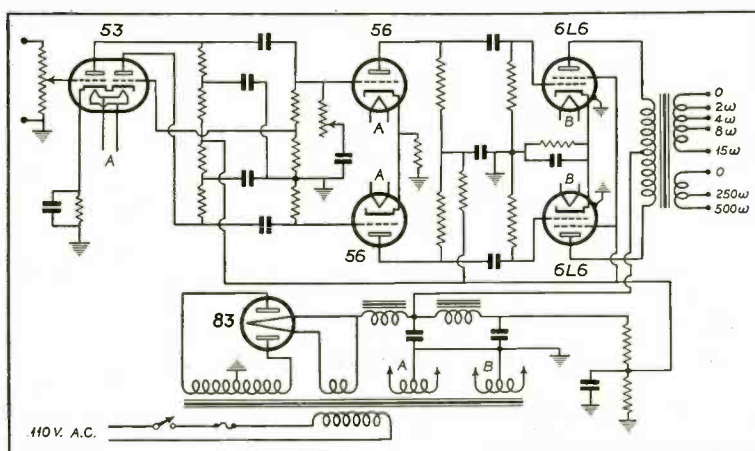

# USE OF BEAM POWER TUBES

as compared with that for other tubes. For example, under certain conditions the static screen current of the 6L6 may be  $4\frac{1}{2}$  mils while the dynamic screen current is  $10\frac{1}{2}$  mils. It is therefore necessary to keep the source impedance of the screen voltage relatively low in order that current drain in these magnitudes may not shift the screen charge sufficiently to affect the tube's power output.

This important consideration is very neatly taken care of, in the design of radio receivers and of some types of amplifiers, by allowing plate current for the remaining portions of the unit to flow through the 6L6 screen resistor. In most cases the current thus added will be in the order of 30 or 40 mils, which is sufficient to permit use of a screen resistor with a value as low as 2,500 ohms. Inasmuch as this supplementary current to the plates of the other tubes will be relatively constant, the total current through the screen resistor may vary between 45 and 50 mils—a change of 5 parts in 50, or 10 per cent, which is entirely tolerable. The screen resistor must of course be heavily by-passed, but no additional cost is encountered by reason of this requirement, since large by-pass condensers are also needed for the other circuits.

The 100-volt drop provided by the screen resistor just mentioned does not constitute the total screen potential, but rather, the amount by which the screen potential differs from that of the plate. This feature also works out very conveniently, since the plate of the 6L6 requires 400 volts, while the plates of most other tubes need from 250 to 300 volts, or essentially the same charge as the 6L6 screen—another feature indicating that the designers of the new tube had in mind the problems of the average engineer.

The full extent of the power supply advantages accruing from the use of the 6L6 are indicated by the tabulation that follows, which refers to the circuits diagrammed in Figs. 1 and 2—power supplies used for high efficiency operation of the 6L6 in current commercial amplifiers. Fig. 1 includes a high-grade power transformer of excellent regula-

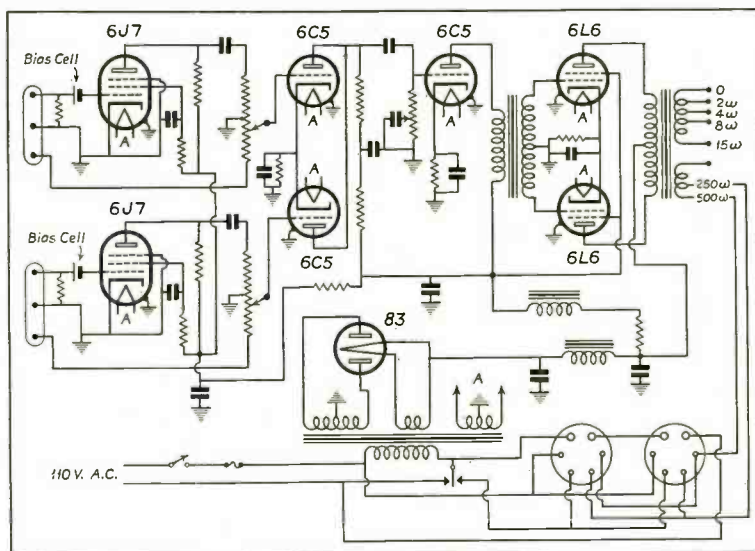

Fig. 2. The More Economical Lafayette Circuit.

tion, and a choke input filter system with chokes of very low resistance. Fig. 2 has a relatively inexpensive power transformer, high resistance chokes and a filter system of the condenser input type that is for most purposes distinctly inferior. Manufacturer's cost for the power supply system of Fig. 1 is 100 per cent greater than that for Fig. 2. The difference in measured results is tabulated herewith:

	Amplifier Fig. 1	Amplifier Fig. 2
$I_p$ No load .....	415	425
* $E_p$ At 25 Watts Output .....	395	380
$E_s$ No load .....	310	325
* $E_s$ At 25 Watts Output .....	295	298
% Total Harmonic Content At 25 Watts Output ...	3	5
*Peak Power Output	35 Watts	35 Watts
*Audio Power at 500 ohms.		

It is obvious from the facts given that the essential differences between these amplifiers must be sought in characteristics other than the results obtained from their power supply circuits. The advantages of the more expensive unit (Fig. 1) are not proportional to the

differences in power supply.

With tubes other than the 6L6, however, the differences in power regulation would be far more pronounced, and the unit diagrammed in Fig. 2 would not in any way approach the quality of the other.

The fact that up to 30 watts can be drawn from a pair of 6L6s without swinging their grids positive, even when operating as Class AB<sub>1</sub>, leaves the designer unrestricted choice as to input circuits. Where frequency response covering the entire audible spectrum is not desired, the output stage can be driven by high-ratio transformers. For the best high-fidelity results, resistance coupling with relatively low-impedance circuits may be used.

Where coupling transformer costs are an important consideration it is entirely feasible to resort to the more economical procedure of using resistance coupling with phase inversion.

The favorable input requirements of the 6L6 interlock with its favorable power supply requirements. The fact that the new tube, up to 30 watts output per pair, is strictly voltage-operated, and needs no driving power, further reduces the specifications and costs for the final unit.

# Design . . NOTES AND

## WESTERN ELECTRIC AIRCRAFT RECEIVER

IN A SINGLE small and light-weight radio receiver for aircraft, Bell Telephone Laboratories have combined three important services for the private flyer. Now, in the limited space available aboard the smaller types of planes, this compact unit may be conveniently installed, bringing to the pilot efficient reception in the beacon and the broadcast bands as well as in the short-wave bands employed for communication with ground stations. This new three-purpose receiver is known as the Western Electric 20 type, and is supplied with or without a small remote control unit, which may be mounted on or near the plane's instrument panel. A flexible cable connecting the remote control unit with the receiver, permits installation of the latter in some out-of-the-way corner of the plane.

The new receiver is a superheterodyne, with one stage of tuned radio-frequency amplification, two stages of intermediate-frequency amplification and two stages of audio-frequency amplification. Four separate frequency bands are provided, the first band being 200 to 400 kilocycles, for beacon and weather stations. The second band is

from 550 to 1500 kilocycles, for commercial broadcast stations. The third band is from 1500 to 4000 kilocycles for aircraft, police and amateur communications, and the fourth band is from 4000 to 10,000 kilocycles, for aircraft and amateur communications and for

foreign broadcast stations.

One form of the receiver has its controls mounted directly on the front panel and is intended for mounting within easy reach of the pilot, whereas the other is provided with a remote control unit on a flexible cable. The diminutive control unit may be mounted flush on the plane's instrument panel, if desired, for convenience and accessibility.

The output of the receiver is 700 milliwatts, which is sufficient to operate as many as six pairs of phones simultaneously if desired. It is so designed that crystal-controlled reception in either or both of the high-frequency bands may be employed, and for this purpose a two-frequency crystal control unit is available to be incorporated in the receiver. One of the crystals may be used in each of the high-frequency bands, or both may be employed in the same band. The definite day and night frequencies for communications between commercial planes and ground stations make this a desirable feature.

A device known as the "varistor" reduces loud static crashes when receiving weak signals, and the automatic volume control is normally used except for beacon reception, where it might interfere with the performance of the receiver for course indication.

The convenient facilities for transferring from one to another of the four frequency bands available, combined



NEW WESTERN ELECTRIC AIRCRAFT RECEIVER.

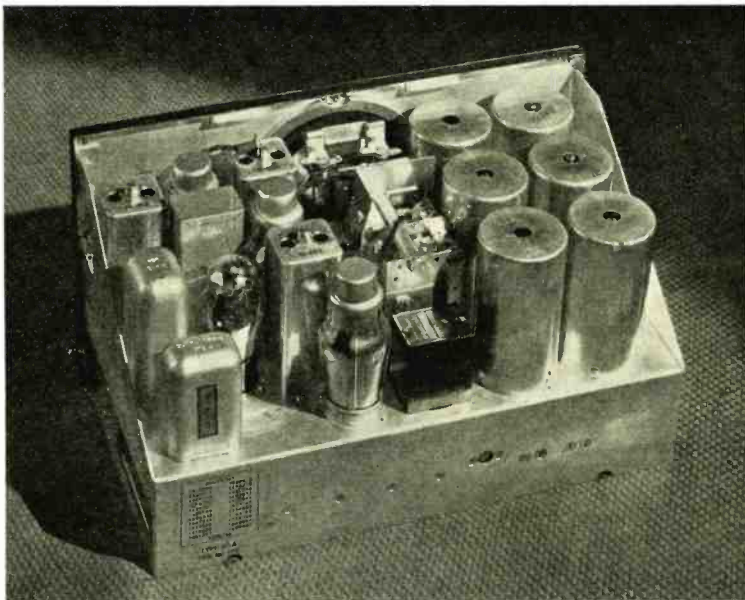

REAR VIEW OF THE WESTERN ELECTRIC AIRCRAFT RECEIVER.



# COMMENT . . Production

with its other features, make this receiver particularly well adapted for marine applications as well as for the use of police and other municipal, county, state and federal agencies. In aviation service, its utility is not confined to the privately-operated plane, but it is also well suited for emergency service in transport and mail planes.

Including its complement of vacuum tubes, the receiver weighs only 14 $\frac{3}{4}$  pounds and measures only 9 inches high, 14 $\frac{5}{8}$  inches wide and 8 $\frac{1}{4}$  inches deep. The unit has been constructed to withstand the rigorous conditions of flying and includes a spot-welded chassis as well as special shock-absorbing rubber mountings.

## POLAROID STRAIN DETECTOR

THE HIDDEN STRAINS that often cause the breakage of beverage bottles, glasses, radio tubes, light bulbs and other pieces of glassware before their useful life has well begun were shown to be instantly visible in a new device demonstrated before the afternoon session of the Society of Automotive Engineers which met on June 2, at White Sulphur Springs, W. Va. The device makes use of Polaroid, a new light polarizing material invented by Edwin H. Land, Boston scientist.

The glassware that was free from strain appeared uniformly dark when placed between the two plates of the Polaroid detector but when glass that contained internal strain was placed between the plates, the strain appeared as streaks or blotches of bright light.

Engineers explained that ordinary inspections cannot uncover internal strains. A piece of glass may look entirely satisfactory when the manufacturing process is over, yet it may actually have within it a severe strain which will cause the glass to go to pieces when it is heated or receives a slight jar in service. The internal strains were declared to be caused by too rapid cooling or improper annealing during the manufacturing process. A baby's bottle or a fruit jar, apparently perfect when it leaves the factory, may nevertheless conceal a strain that will end the life of the article abruptly and even dangerously when it is put into use.

Manufacturers of bottles, plate and window glass, light bulbs and radio tubes and other products made of glass are expected to find a wide use for the device in detecting the strains in the articles before they are shipped and in correcting the manufacturing processes that caused them. It is also believed that the device will make it possible to eliminate a large proportion of the breakage which now occurs in glass factories during annealing operations. A radio tube manufacturer, for example, was reported to have cut the breakage in half on one machine after observing the product in the Polaroid Strain Detector. Chemists and other laboratory workers are already using the device for inspecting their glassware for the hidden strains that often cause the failure of the apparatus and the loss of weeks of effort on long experiments.

Land explained that the device de-

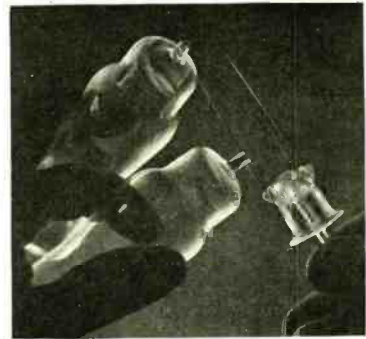

STRAINS DUE TO IMPROPER ANNEALING; WHITE AREAS INDICATE STRAINS.

pends for its operation upon the crystalline characteristics developed by transparent materials which are ordinarily non-crystalline. "When a material like glass or transparent bakelite is free from strain," he declared, "it is homogeneous all the way through and has no crystalline characteristics. If it is subjected to stress, however, either internally because of faulty annealing or externally through the application of outside forces, it develops semi-crystalline characteristics at the points where the strain is concentrated. When the object is viewed under polarized light these points will appear as bright or colored areas, because of the effect which these crystalline portions have on the polarized light passing through."

Land explained that the detector operates on a principle well known to physicists and employed in a great number of laboratories for many years. Because the sources of polarized light are extremely expensive and inconvenient to use, however, the principle has never gotten far beyond the laboratory stage. With the invention of Polaroid the apparatus is converted from a laboratory curiosity to a working tool for industry.

Designers are using the new device not only for the simple detection of strain, but for the calculation of the amount of stress which causes it. Demonstrating the principle with simple parts made of transparent Bakelite and Marbette, Land showed how structural parts such as beams, gear wheels, shafts, and other load-carrying members could be subjected in the tester to loads corresponding to those which the parts were to carry in service. Brilliantly colored bands appeared in the parts, with the highest concentration of color and frequency occurring at the points of greatest strain. It was stated that from:

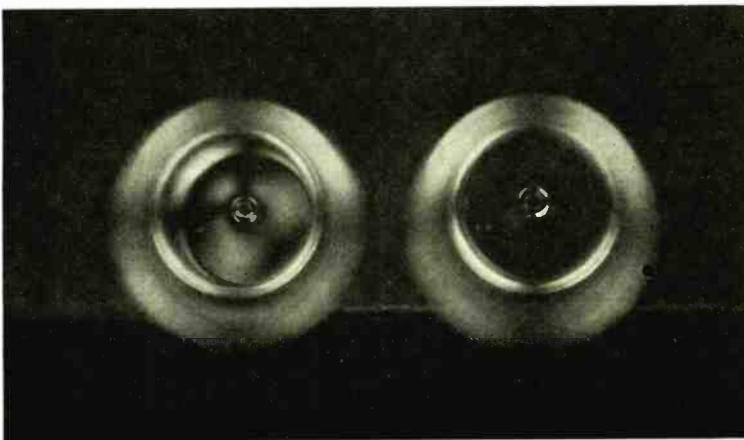

LEFT, STRAINS IN DOME OF TUBE CAUSED BY FAULTY ANNEALING. RIGHT, AFTER CORRECT ANNEALING.

the shape, placing and color of the bands a trained technician can calculate the amount of strain involved and the resulting data may be used as a basis for the design of the finished parts.

### NEW TUBE VISUALIZES ELECTRONS

MAKING ELECTRONS "VISIBLE" to simplify the study of electronic phenomena is now possible through the use of a new tube developed by engineers of the Westinghouse Lamp Company, Bloomfield, N. J. The new tube has a fluorescent coating on the plate that "illustrates" electron bombardment for demonstration purposes, such as in laboratories, high schools and colleges.

Like the other three-element electronic tubes in fundamental design, the new tube has been especially constructed with a fluorescent coating on the plate. Electrons striking this coating are transformed into visible bands of radiations whose widths depend directly upon the electron beam intensity. Thus, the electrons passing through the grid to the anode form a visible pattern which corresponds to the invisible pattern in a more conventional tube.

The effects of grid voltage on this transmission are illustrated by changes produced in the strips of light on the plate. A constant, high negative grid

voltage will reduce the bands to fine lines, while a constant positive voltage on the grid will cause the bands to expand to widths sufficient to cover the plate completely. Thus, it is possible to illustrate the fact that a direct relationship exists between the electron flow in a tube and its plate current, namely, that a change in the flow produced by the grid in turn varies the plate current.

### INAUGURATION OF DAILY TELEVISION BROADCAST SCHEDULE

CULMINATING SEVERAL YEARS of pioneering experimentation, a television receiver that is believed to have achieved a new peak in the clarity of the image transmitted, has been perfected by Harry R. Lubcke, director of the television division of the Don Leo Broadcasting System.

Simultaneous with the announcement of the new instrument's completion came the word that the Don Leo experimental station, W6XAO, would immediately assume a regular daily schedule of broadcasting. Demonstration of the transmitter and cathode-ray tube receiver was witnessed on Thursday, June 4, by radio editors and other press representatives of metropolitan Los Angeles.

Justly proud of the achievement in the field to which he has consistently given

every possible encouragement and support, Thomas S. Lee, president of the Don Leo Broadcasting System, announced that, beginning Friday, June 5, the receiver which has been perfected in the Don Leo Laboratory will be available for inspection by any and all interested persons.

The cathode-ray tube receiver, only recently perfected by Director Lubcke and his associates is the culmination of experimental and test work begun in 1930, conducted for the most part behind closed doors. Television transmissions have gone out from W6XAO since December 1931, images being received over the air and not by means of wires.

The receiver and system in general are based on patents of Mr. Lubcke who declares that the equipment and principles involved are in radical departure from those of other television investigators and represent the Don Leo Broadcasting System's contribution to the progress of the art.

It consists of the cathode-ray tube unit; two scanning sources; the television receiver proper, and the power supply. The television receiver proper serves to convert the television ether waves into electrical pulsations which are properly reproduced on the cathode-ray tube screen with the co-action of the scanning sources. The images are composed of 300 lines and are repeated 24 times per second.

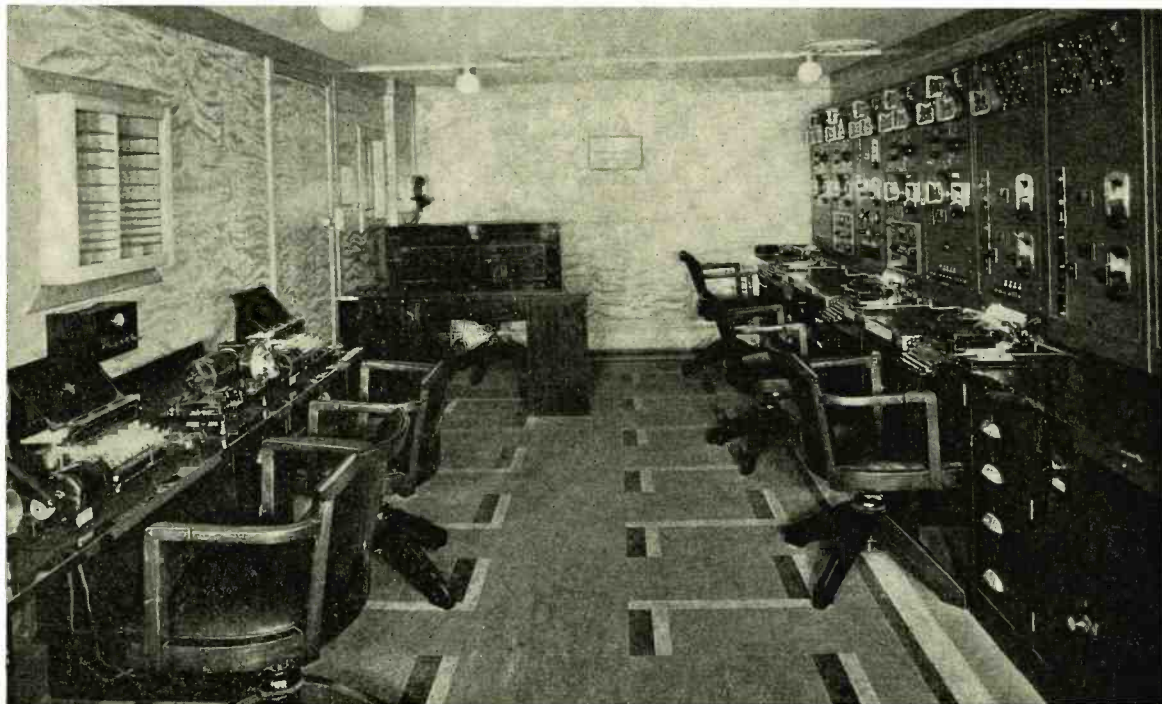

*Courtesy, I. T. & T.*

Part of the radio control room on QUEEN MARY showing (left) automatic high-speed Creed equipment; (center background) supervisor's control desk, and (right) some of the operators' positions with receiving equipments.

# NEWS OF THE INDUSTRY

## AEROVOX WINS PATENT DECISION

A suit brought by Aerovox Corporation against Micamold Radio Corporation for infringement of two of its patents for electrolytic condensers was decided in favor of Aerovox Corporation in a decision handed down May 14, 1936, by Judge Marcus B. Campbell of the Federal Court for the Eastern District of New York. The decision was in favor of Aerovox Corporation on all claims involved in the suit and an injunction and an accounting were ordered.

These patents had been previously held valid and infringed by the United States Circuit Court of Appeals in the Southern District of New York. In the present suit the Micamold Radio Corporation alleged newly discovered evidence. Judge Campbell found such new evidence irrelevant.

## REMOTE CONTROL CATALOG

The F. W. Stewart Manufacturing Corp., 340 West Huron Street, Chicago, Ill., have available a catalog showing their complete line of remote control dial and cable equipment for auto-radio receivers.

## "RCA REVIEW"

A new quarterly publication devoted primarily to technical papers on communication, broadcasting, television and the electronic and audio arts will make its initial appearance in June, under the title of "RCA Review." It will be published and distributed through the RCA Institutes Technical Press, a department of RCA Institutes, Inc., 75 Varick Street, New York.

## CONVERTER BULLETIN

"Notes on Converter Operation," discussing the 6A8 and 6L7 types, has been made available by the National Union Radio Corp., 570 Lexington Avenue, New York, N. Y.

## MALLORY BULLETINS

The following bulletins have been received from P. R. Mallory & Co., Inc.: Mallory Grid Bias Cells; Mallory Condensers; Yaxley Radio Parts; Mallory Rectifiers; and Yaxley 3100 Type Switches. Copies may be obtained from the company at Indianapolis, Ind.

## GEAR CATALOG

A new 128-page catalog describing the complete line of spur, bevel, worm and other gears, also motorized speed reducers, etc., manufactured by The Ohio Gear Company, 1333 East 179th Street, Cleveland, Ohio, is now available on request. In addition to the above information, it furnishes useful technical data on gearing, S. A. E. standard heat-treatment methods, and other handy facts.

## GUTHMAN MOVES

Faced with the necessity of providing greater production facilities, the Edwin I. Guthman Company of Chicago, manufacturers of r-f and magnet coils, moved on May 25 to a new location at 400 South Peoria Street, Chicago, where they will occupy the entire fifth floor in both the north and south Addressograph Buildings, with a total floor space of about 25,000 square feet. Additional equipment and machinery is being installed to enable the Guthman Company to render more efficient service and handle a greater volume of production.

## KEN-RAD TUBES

"The 6L6 Beam Power Amplifier" is the title of a new 22-page engineering bulletin just published by The Ken-Rad Corporation, Owensboro, Kentucky. This bulletin is complete, giving detailed information and showing charts of the Ken-Rad 6L6, a cathode type power amplifier tube designed for the output stages of radio receivers and audio power amplifiers. It is of all-metal construction and has the operational characteristics of high power output, high power sensitivity and high efficiency. This interesting bulletin may be obtained by writing The Ken-Rad Corporation, Inc., Owensboro, Kentucky.

When the Ken-Rad Electron-Ray Indicator type 6E5 first appeared on the market numerous users of this new device indicated a desire to utilize the tube in a-c, d-c receivers. In such applications the maximum plate voltage available is usually in the order of 100 volts. Recent advances in the engineering and manufacturing of this tube have been made so that satisfactory performance is now obtained at this lower voltage. A 100-volt rating is now being issued on both the 6E5 and the more recently announced remote cut-off type, the 6G5. These new ratings will enable the manufacturer of a-c, d-c receivers to incorporate this very useful device in these receivers.

## AIR EXPRESS SHOWS 68 PERCENT GAIN FOR MARCH

A summary of the reports of agents of the 215 airport cities served directly by Air Express Division of Railway Express Agency shows an increase of more than 68 percent for March, 1936, over March, 1935, in the total amount of air express business handled over its contract airlines.

While many rail-air shipments are included in the above preliminary report yet all of the returns for co-ordinated rail-air business from the 23,000 off-air line offices are not included. In addition to an unusual amount of printed matter there were many heavy shipments flown to flooded districts.

## MILLER CATALOG

Catalog No. 36, on radio coils and allied products, has been made available by the J. W. Miller Co., 5917 South Main Street, Los Angeles, Cal.

## LENZ WIRE CATALOG

Lenz Electric Manufacturing Co., 1751 North Western Ave., Chicago, Ill., have released a new catalog of their wires and cables. Suggested uses for the various types of wire, along with technical data, are given in this catalog which may be obtained from the company at the address given.

## P-A CATALOG

A new 48-page catalog describing the complete 1936 line of Lafayette public-address amplifiers, systems and accessories is announced by Wholesale Radio Service Co., Inc.

Amplifiers ranging in power output from 3½ to 100 watts, suitable for a wide variety of applications from kitchen call-systems to theatre "talkies," are listed.

Copies of this catalog are obtainable from any of the Wholesale Radio Service Co., Inc., offices at the following addresses: 100 Sixth Avenue, New York, N. Y.; 901 West Jackson Blvd., Chicago, Ill.; 430 W. Peachtree St., N. W., Atlanta, Ga.; 219 Central Avenue, Newark, N. J., and 542 East Fordham Road, Bronx, N. Y.

## DATA ON ELECTRONIC TUBES

The many new and improved electronic tubes permitting wider industrial application has resulted in the preparation of a set of new data sheets covering tube ratings and characteristics, that may be obtained by writing to the Special Products Department, Westinghouse Lamp Company, Bloomfield, N. J.

The new sheets describe ratings and operating characteristics of amplifier and oscillating tubes; grid-glow tubes and ignitrons; phototubes; rectifier tubes; and miscellaneous types, all of which are manufactured by the Westinghouse Lamp Company. The new data supersedes similar information included in the engineering catalogue of July, 1934.

## RCA SHORT-WAVE LINK

R. C. A. Communications, Inc., gave the first public demonstration of its new, ultra-short-wave radio circuit connecting New York and Philadelphia on Thursday, June 11.

Press representatives were invited to be present at the New York and Philadelphia terminals of the circuit. In New York the terminal is at 66 Broad Street; in Philadelphia the terminal is in the Fidelity Philadelphia Trust Company Building, 1335 Walnut Street.

## FERRANTI MOVES

Ferranti Electric, Inc., manufacturers of transformers, instruments, surge absorbers, have just announced the removal of their executive and sales offices to larger quarters at 30 Rockefeller Plaza, New York City. Mr. W. R. Spittal, Manager, stated that this move was necessary due to increased sales of all Ferranti products.

# NEW PRODUCTS

## CENTRALAB CERAMIC SWITCHES

Centralab, 900 East Keefe Avenue, Milwaukee, Wisconsin, has developed a new switching device for use in radio circuits where a low-loss, low-capacity multi-section switch is required. This switch incorporating a true Isolantite base, to which are attached sturdy, double-bite clips with low contact resistance and free from all looseness or rocking, is available in a multiplicity of designs.

The wax impregnated Isolantite base, incorporating material with an exceedingly low loss factor, should find usefulness in any high-frequency or ultra-high-frequency switching circuit where excessive losses become the controlling factor in design.

These switches will be engineered to meet individual requirements upon receipt of detailed information as to the switching circuit and mechanical specifications desired. Write for Centralab specification form 380.

## THERMOSTATIC BIMETAL

Callite Products Co., 540 Thirty-ninth Street, Union City, N. J., announces a thermostatic bimetal which is said to have many new features of importance. Four grades of the material are available for various temperature ranges, one grade being especially adapted for use in humid atmospheres.

## UNIVERSAL RECORDER

Universal Microphone Co., Inglewood, Cal., in May issued the 1937 model of its professional recording machine, which is said to incorporate several new scientific developments.

The new model is designed for cutting from the inside out or the outside in. There is a special timing bar with the speed regulated at 90, 110 or 130 lines per inch.

Other improvements include a new motor and a novel development in the counter shaft which allows instantaneous changing or any speed or lines per inch combination desired.

The turntable is of a more massive design than the previous model, and the new floating head, designed the first of this year, incorporates adjustments for changing both the vertical and the lateral angularity. There is also an exclusive micrometer adjustment.



## RAYTHEON TUBES

The 6L6G is equipped with an octal base and is in an St-16 bulb. Stem press insulation is more than adequate to care for transient voltages which are likely to appear in the plate circuit of such a high power amplifier.

Raytheon's list of octal based tubes has been prepared to clarify the new type tube situation for the set design engineer, service man, distributor and dealer. It is up to date, incorporating a decision just made to designate all unshielded glass tubes equipped with the octal type base with a suffix G following the type designation. Thus, the 6P7, which is the octal equivalent of the 6F7, will be known as the 6P7G.

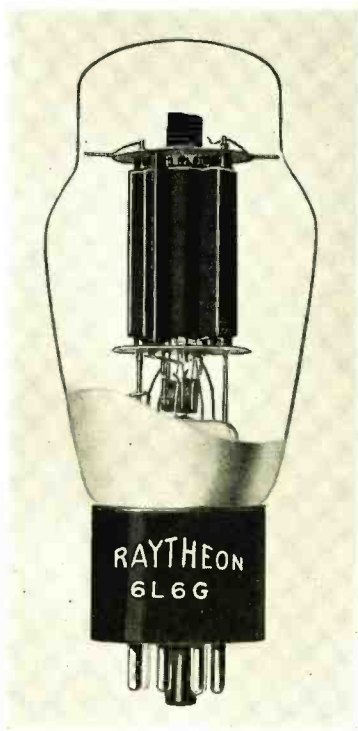

The Raytheon Engineering Department reports the perfection of a method for spinning Isolantite grid cap insulation wafers into metal tubes designed for conversion and r-f amplification. The use of Isolantite in place of bakelite reduces r-f losses in the grid circuit of tubes like the 6A8, 6L7 and 6K7 to values equivalent to the lowest glass bulb losses.

Receiver engineers who have been using Raytheon metal tubes with the new Isolantite grid insulation report definite gains in performance on high frequencies. The improvement is expected to be even more noticeable in sets designed to cover the ultra-high-frequency channels.

## SMALL METAL-CAN ELECTROLYTICS

A marked reduction in bulk for a given capacity is achieved in a new line of dwarf units just announced by Aerovox Corporation, 70 Washington Street, Brooklyn, N. Y. Known as the GLS series, these new electrolytics are of a uniform 1" diameter but vary in height from 2-3/16" for the 4-mfd units, to 4 3/8" for the 16-mfd. Two voltage ratings are available—the GLS5 or 450 d-c voltage, 525 surge peak, and the GLS250 or 250 d-c voltage, 300 surge peak. Capacities of 4, 8, 12 and 16 mfd are offered.

## ULTRA HIGH RANGE RESISTOR

In response to many requests from physicists and engineers for a stable, ultra-high-range, non-inductive, high-voltage resistor, the International Resistance Company announces satisfactory solution of the unique problems common to high values in two new IRC resistor types, the metalized "FH-1" and Type "MG." These new Types FH-1 and MG resistors are described in a catalogue recently issued, which may be had by writing the International Resistance Company, 401 N. Broad Street, Philadelphia.

## RCA ITEMS

The RCA Parts Division has announced the following: the Spider-Web Antenna, which is said to give full frequency coverage with minimum space requirements; three auto-radio antennas; a cathode-ray tuning indicator, permitting the installation of the tuning indicator tube in any avc equipped receiver; and several types of transformers, both audio and power.

Complete information may be obtained from RCA Parts Division, RCA Manufacturing Co., Inc., Camden, N. J.

## UNITED TRANSFORMERS

United Transformer Corp., 72 Spring Street, New York City, has designed a new series of ultra-compact audio units as companions for acorn and metal type vacuum tubes. They measure up to good broadcast standards, having a response plus or minus 2 db from 30 cycles to 20,000 cycles. Average weight 6 1/2 ounces, overall dimensions, 1-7/16" x 1-7/16" x 1-15/16".

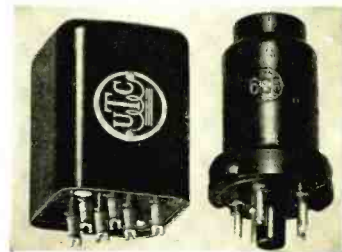

Here Next Month:  
**Tru-Fidelity**

by  
**THORDARSON**  
Most Sensational  
Audio Development  
in Radio History

● **WAXES**  
● **COMPOUNDS**  
● **VARNISHES**

For Insulation of Condensers

Transformers, coils, power packs, pot heads, sockets, wiring devices, wet and dry batteries, etc. Also WAX SATURATORS for braided wire and tape WAXES for radio parts. Compounds made to your own specifications if you prefer.

● **ZOPHAR MILLS, INC.**

FOUNDED 1846

Court, Lorraine and Creamer Sts., Brooklyn, N. Y.

**YOU NEED THIS  
INSTRUMENT**

The Acme Voltrol is a full range manual voltage regulator providing complete control over primary voltage in a stepless range from 0 to 130 volts. Accurate 1/2 volt adjustments. Every laboratory needs Voltrol. Write for free bulletin 136.



**THE ACME ELECTRIC  
& MFG. CO.**

1450 Hamilton Ave., Cleveland, Ohio

**CONTACTS**

**TUNGSTEN  
AND  
MOLYBDENUM**

ROD, SHEET AND WIRE  
SPECIAL SHAPES

**KULGRID**

For Grids, Round or Flat  
Also Kulgrid "C" Tungsten Welds

**CALLITE PRODUCTS CO.**

542 — 39TH STREET

UNION CITY, N. J.

*A recognized source of supply for*  
**RADIO PARTS**  
of Copper and Copper Alloys



VACUUM tube base pins, plug and socket parts, eyelets, rivets, grommeters, terminals, contacts, aerial hardware, electrodes, fuse clips, sockets, screw shells, condenser shells, miscellaneous stampings, shells, etc. The Waterbury Brass Goods Corp., as this division of The American Brass Company was formerly known, has long been a recognized source of supply for these and similar radio parts of copper and copper alloys.

*Terminals*

We maintain hundreds of tools and dies for producing terminals in an almost endless variety of styles and sizes. The use of stock terminals is recommended as an advantage in prompt delivery and lower tool and production cost. As a service to customers our engineers will recommend the stock terminal best suited for any requirement, provided samples or drawings of the parts with which it is to be used are submitted for inspection. This service involves no obligation.



The comprehensive scope of our lines and the unvarying high quality of our products . . . combined with prompt and efficient handling of orders and inquiries . . . provide an ideal service for manufacturers of electrical and radio equipment. May we quote on your present requirements or cooperate with you in designing new parts from the standpoint of production economy?



WATERBURY BRASS GOODS BRANCH

*The American Brass Company*

General Offices: Waterbury, Connecticut

## INDUCTOR SWEEP OSCILLATOR

From the laboratories of Kendall Clough comes another development in test oscillator design. The Clough-Brengle Model OM-A Frequency Modulated R.F. Signal Generator is the instrument embodying this new frequency sweep principle. In place of complicated moving parts or involved tube circuits with consequent instability, the "Inductor Sweep" simply employs a small copper vane which is rotated in the magnetic field of the oscillator coil. As this vane rotates, it causes the inductance of the coil to vary sufficiently to cause a plus and minus 20 kc "wobble" of the oscillator output frequency. Rotation is secured by a synchronous motor, operating at what is practically zero load.

A new bulletin, describing in detail the operation of this new principle, may be secured by writing to the manufacturer, the Clough-Brengle Co., 1134 W. Austin Ave., Chicago, U. S. A.

## BRUSH PHONES

The Brush Development Co., East 40th Street at Perkins Avenue, Cleveland, Ohio, has just announced the introduction of two new models of Brush crystal headphones to supplement the Brush Type A 2-phone model that has already won such wide popularity and customer acceptance throughout the country.

First of these two new developments is a single phone instrument with head band and soft rubber pad which holds the phone securely in place against the ear of the user.

Second of the new models is also a single phone instrument . . . but with the phone mounted on a 12-inch lorgnette handle.

## ALSIMAG (STEATITE) 35 INSULATING BEADS

Description: These white beads are of the ball and socket type for use on flexible leads of various sizes. The material is Alsimag (Steatite) 35 which is well known



for its desirable appearance, mechanical strength and low electrical losses.

There are seven sizes suitable for wires ranging from .032 dia. to .162 dia. The data pertaining to the several sizes is listed below for reference:

Alco No.	O.D.	I.D.	Length	Wire Size
E-2602	.110	.056	.110	20 AWG (.032)
E-2496	.170	.068	.170	14 AWG (.064)
E-2603	.200	.092	.200	14 AWG (.064)
E-2739	.260	.116	.260	9 AWG (.114)
E-2604	.260	.152	.260	8 AWG (.128)
E-2605	.400	.156	.400	8 AWG (.128)
E-2920	.400	.180	.400	6 AWG (.162)

A card showing sizes, and mounted samples will gladly be supplied upon request to American Lava Corp., Chattanooga, Tenn.

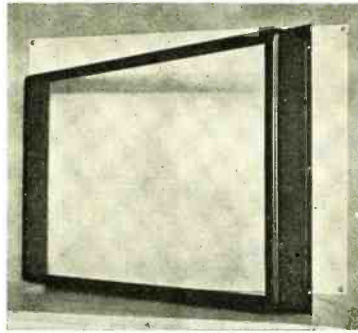

## METER ENCLOSURES

Special meter enclosures, fitted with plate glass, and available in any size to order, may now be obtained from the Radio Engineering and Mfg. Company, 26 Journal Square, Jersey City.

These enclosures should not be confused with the ordinary "bent" metal types, as special dies were made in order to produce an enclosure with heavily rounded corners, with all seams welded and filed smooth, it is stated.

Standard finish is dull rubbed black, with any other color supplied upon order. Write for price list.

## OXFORD-TARTAK SPEAKERS

A new series of improved magnetic speakers—for midget a-c, a-c-d-c and battery sets—for hotels, schools, announcing systems and other multiple-unit p-a installations, and for extension use on any home or auto radio set—is announced by the Oxford-Tartak Radio Corporation, 915 W. Van Buren St., Chicago. These Oxford reproducers are available in 5", 6½" and 8½" models. They have heavy pressed steel cadmium plated frames, heavy magnets with improved balanced armature unit, and extra-flexible diaphragms.

## G-R SIGNAL GENERATOR

The type 605-A Standard Signal Generator just announced by the General Radio Company, is said to possess several distinctive features which make for greater ease of operation and accuracy of adjustment. Among these may be mentioned: direct reading, doing away with calibration charts; a-c operation with built-in voltage regulator; vacuum-tube voltmeter to indicate carrier amplitude. If desired, the generator may be had in a battery-operated model.

Bulletin 22-K, which completely describes this new instrument, may be obtained by writing to the General Radio Company, 30 State Street, Cambridge, Mass.

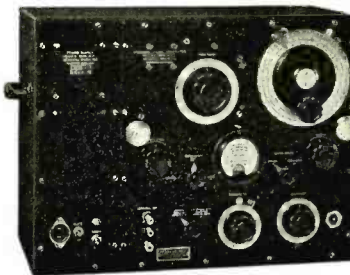

## HYGRADE SYLVANIA ELECTRONIC DEVICES

Hygrade Sylvania Corp. has announced that their Clifton, N. J., plant has enlarged facilities and new equipment for the manufacture of high-quality electronic devices and component parts; they will be pleased to receive inquiries or specifications from the industry.

Mr. A. H. Hotopp is the general manager and chief engineer.

## SENCO VARI-SPEED MOTOR

Constant speeds with less than 1% drift, variable from 0 to 1000 rpm by turning a small calibrated dial are possible with the new Senco Vari-Speed Drive developed by the Sundt Engineering Company of Chicago, affiliate of Littelfuse Laboratories.

The unit is powered by a 1/100 hp 110-v. shaded induction motor and the speed is changed by means of special wear resistant friction disc clutch. Oilless bearings are used throughout. The average torque is 1.0 inch-pounds. A 10 to 1 reduction is available for slow speeds. Attractively finished, the unit measures only 8½ by 3½ by 4½ inches and weighs 10 pounds.

While this unit was designed primarily to provide a synchronous scanning system for use with the Senco Neon Oscilloscope Tube, it has many other shop and laboratory uses; sweeps for cathode-ray tubes, stroboscope systems, timing and control devices, automatic switches, advertising displays and novelties, laboratory life tests, lecture room demonstrations, etc.

A pamphlet is available that describes many applications for this unit.

## DAVEN "T" ATTENUATOR

A 30-step "T" network is available from The Daven Company, Newark, New Jersey. This unit, known as type "T-330," is applicable to low-level mixing due to its zero insertion loss, constant input and output impedance at all settings of the dial, wide attenuation range, and extremely low switch noise level, it is stated.

A new wiping-type, balanced, multi-leaf, switch has been developed requiring low but constant torque at all settings. A new type of switch stop is employed which removes the strain from the switch blades.

The attenuator is offered in all popular impedances from 30 to 600 ohms with attenuation of 1.5 db per step. To provide a smooth complete fade-out the loss per step is increased on the last few contacts. Unequal input and output impedances designed for minimum loss may be obtained upon request.

This unit is interchangeable electrically and mechanically with the popular ladder-type attenuators. The size is only 2½ inches diameter, 2½ inches back of panel space. The net weight is 12 ounces. Send for Bulletin TRE-534.

## DISTRIBUTION PANEL

The latest product of the Radio Engineering and Mfg. Co., Jersey City, N. J., is a sound distribution panel, useful in centralized sound systems, in hotels, amusement parks, auditoriums, etc., where several branch circuits are loaded on the output of the main power amplifiers, and a certain audio level must be maintained in each circuit.

Here Next Month:  
**Tru-Fidelity**

by  
**THORDARSON**  
Most Sensational  
Audio Development  
in Radio History

## These Advertising Pages

reach the 6,000 important radio executives, engineers, production managers and purchasing agents every month. . . .

## If You Have A Message

tell it to these men. Get in touch with our advertising department TODAY!

*Experienced merchandising and selling advice, given freely.*

**RADIO ENGINEERING**  
19 E. 47th Street, New York City

*By Preference*  
it's  

- In Cleveland it's*  
 **The HOLLENDEN**
- In Columbus it's*  
 **The NEIL HOUSE**
- In Dayton it's*  
 **The BILTMORE**
- In Akron it's*  
 **The MAYFLOWER**
- In Toledo it's*  
 **The NEW SECOR**
- In Savannah (Ga) it's*  
 **The GENL OGLETHORPE**
- In Miami Beach it's*  
 **The FLEETWOOD**

**DeWitt Operated Hotels**

*feature*  
Unusually Comfortable Rooms at Reasonable Rates, and the finest of Food and Beverages, Carefully Prepared and Served.

# ACME LITZ

**REDUCES  
MANUFACTURING  
COSTS** in the production of  
I.F. and R.F. coils

1. Ease in Winding
2. Uniformity
3. Low Rejections

### Other ACME WIRE CO. Products

MAGNET WIRE (All Insulations)  
COILS (Magnet Wire Wound)  
VARNISHED INSULATIONS (Cambric, Paper, Silk, Tape)  
PARVOLT CONDENSERS (Filter, By-pass,  
Power Factor Correction)  
AERIAL WIRE (Stranded or Solid, Bare or Enameled)

**THE ACME WIRE CO.**  
NEW HAVEN, CONN.

*For over 30 years, suppliers to the largest  
radio and electrical manufacturers*

**A COMPLETE  
STOCK...  
PROMPT  
SERVICE!**

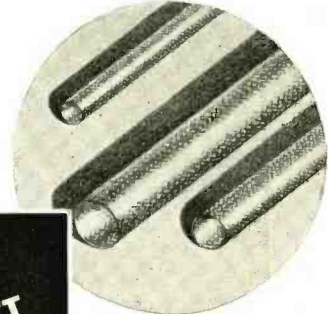

**BRAND  
TURBO OIL  
TUBING**

Thirty different diameters, a dozen different colors, a stock sufficient to meet your most pressing production requirements. Smooth Inside Bore Turbo Oil Tubing is the ideal insulating spaghetti—retaining its high insulating and sturdy mechanical properties when exposed to oils, acids, moisture, high temperatures and severe usage. Will not crack or become brittle due to age, twisting or bending. Other Brand Insulations: Turbo Saturated Sleeving, Varnished Cambric Cloths, Tapes and Papers. Test samples available. Send for complete catalog.

**WILLIAM BRAND & COMPANY**  
276 FOURTH AVE. 217 NO. DESPLAINES ST.  
NEW YORK, N. Y. CHICAGO, ILL.  
SINCE 1920 THE FINEST IN INSULATION

**BRAND  
INSULATION**

# RADIO ENGINEERING BUYER'S GUIDE

A continuous, indexed recording of the reliable sources of supply of

# Materials—Component Parts

## ALLOYS, RESISTANCE

**AMERICAN ELECTRO METAL CORP.**, Lewiston, Maine  
**CALLITE PRODUCTS DIV.**, 542 39th St., Union City, N. J.  
 Cleveland Wire Cloth & Mfg. Co.  
 Driver Company, Wilbur B.  
 Driver-Harris Company  
 Fansteel Metallurgical Labs.  
 Hoskins Mfg. Co.  
 Jelliffe Company, C. O.  
 Trembles & Company, Geo.  
**NEWARK WIRE CLOTH CO.**, Newark, N. J.

## ARRESTORS, LIGHTNING

Birnbach Radio Corp.  
 Knox Porcelain Co.  
 Johnson Co., E. F.

## BASES, VACUUM TUBE

**AMERICAN LAVA CORP.**, Chattanooga, Tenn.  
 American Phenolic Corp.  
 American Record Corp.  
**ISOLANTITE, INC.**, 233 Broadway, N. Y. C.  
 Kurz-Kasch Co.  
**RCA MFG. COMPANY, INC.**, Camden, N. J.  
 Westinghouse Lamp Co.

## BRASS—COPPER

**AMERICAN BRASS CO., THE**, Waterbury, Conn.  
**ANACONDA COPPER CO.**, 25 Broadway, N. Y. C.  
 Baltimore Brass Co.  
 Bristol Brass Corp.  
 Ryerson & Son, Inc.  
 Seville Mfg. Co.

**WATERBURY BRASS GOODS BR.**, Waterbury, Conn.

## CABINETS—WOOD

Adler Mfg. Co.  
 Alden Corp.  
**EXCEL WOODCRAFT CORP., THE**, Columbus Rd. at Leonard St., Cleveland, Ohio  
 Peerless Cabinet Co.  
 Superior Cabinet Corp.

## CATHODES (See Tubing, Seamless Cathode)

### CATHODE RAY—TUBES

**DUMONT LABORATORIES, ALLEN B.**, 542 Valley Rd., Upper Montclair, N. J.  
 General Electric Co.  
**HYGRADE-SYLVANIA CORP.**, Clifton, N. J.  
**RCA MANUFACTURING CO., INC.**, Camden, N. J.  
**WESTERN ELEC. CO.**, 195 Broadway, N. Y. C.  
 Westinghouse Elec. & Mfg. Co.

### CATHODE RAY—OSCILLOGRAPH

**CLOUGH-BRENGLE CO.**, 1134 W. Austin St., Chicago, Ill.  
**DUMONT LABORATORIES, ALLEN B.**, 542 Valley Rd., Upper Montclair, N. J.  
**RCA MANUFACTURING CO., INC.**, Camden, N. J.  
**WESTERN ELEC. CO.**, 195 Broadway, N. Y. C.

## CERAMICS

**AMERICAN LAVA CORP.**, Chattanooga, Tenn.  
 American Phenolic Corp.  
 Colonial Insulator Co.  
 Crowley & Co., Henry L.  
 Dielectric Products Co.  
**ISOLANTITE, INC.**, 233 Broadway, N. Y. C.  
 Kirchner & Co., Inc., M.  
 Myselox Corp. of Amer.  
**STUPAKOFF LABORATORIES, INC.**, 6627 Hamilton Ave., Pittsburgh, Pa.

## CHOKES

**ACME ELECTRIC & MFG. CO.**, 1440 Hamilton Ave., Cleveland, Ohio  
**AMERICAN TRANSFORMER CO.**, 175 Emmet St., Newark, N. J.  
 General Transformer Co.  
**HAMMARLUND MFG. CO.**, 424 W. 33rd St., N. Y. C.  
 Kenyon Transformer Co., Inc.  
**UNITED TRANSFORMER CORP.**, 72-74 Spring St., N. Y. C.

## COIL MACHINERY

**UNIVERSAL WINDING CO.**, Providence, R. I.

## COILS—POWER

**ANACONDA WIRE & CABLE CO.**, Muskegon, Mich.  
**ACME WIRE COMPANY**, 1255 Dixwell Avenue, New Haven, Conn.  
 American Enamelled Magnet Wire Co.  
 Beiden Manufacturing Co.  
**WESTON COIL CO., INC.**, Providence, Rhode Island  
**GENERAL ELECTRIC COMPANY**, Schenectady, N. Y.  
 Roebbling's Sons, John  
 Westinghouse Elec. & Mfg. Co.

## COILS—RADIO RECEIVER

**ALADDIN RADIO INDUSTRIES, INC.**, 466 W. Superior St., Chicago, Ill.  
**ALDEN PRODUCTS CO.**, Brockton, Mass.  
 Automatic Winding Co.  
**COTO-COIL CO., INC.**, Providence, Rhode Island  
**ELECTRICAL WINDING CORP.**, 22-26 Wooster St., N. Y. C.  
 General Mfg. Co.  
**GUTHMAN & CO., INC.**, Edwin I., 1036 W. Van Buren St., Chicago, Ill.  
**HAMMARLUND MFG. CO.**, 424 W. 33rd St., N. Y. C.  
 Melstner Mfg. Co.  
 National Company  
 Siskies Company

## COILS—SPEAKER

**ACME ELECTRIC & MFG. CO.**, 1440 Hamilton Ave., Cleveland, Ohio

**AMERICAN TRANSFORMER CO.**, 175 Emmet St., Newark, N. J.  
**ANACONDA WIRE & CABLE CO.**, Muskegon, Mich.  
 Chicago Transformer Corp.  
 Dongan Electric Mfg. Co.  
**GENERAL TRANSFORMER CORP.**, 502 S. Throod St., Chicago, Ill.  
 Halldorson Company  
**JEFFERSON ELECTRIC COMPANY**, Bellwood, Ill.  
 Kenyon Trans. Co., Inc.  
**RCA MANUFACTURING CO., INC.**, Camden, N. J.  
**STANDARD TRANSFORMER CORP.**, 854 Blackhawk Street, Chicago, Ill.  
 Thunderson Elec. Mfg. Co.  
**UNITED TRANSFORMER CORP.**, 72-74 Spring St., N. Y. C.

## CONDENSERS, FIXED PAPER

**ACME WIRE COMPANY**, 1255 Dixwell Ave., New Haven, Conn.  
**AEROVOX CORP.**, 90 Washington St., Brooklyn, N. Y.  
**CORNELL-DUBILIER CORP.**, 4388 Bronx Blvd., N. Y. C.  
**CURTIS CONDS. CORP.**, 3088 W. 106th St., Cleveland, O.  
**ELECTRONIC LABORATORIES, INC.**, Indianapolis, Ind.  
 Flechtheim & Co., A. M.  
 Girard-Hopkins, Inc.  
 Magnavox Co., Ltd.  
**MALLORY & CO., P. R.**, Indianapolis, Indiana  
 Micaemold Radio Corp.  
 Polymet Mfg. Co., Inc.  
**SOLAR MFG. CORP.**, 599-601 Broadway, N. Y. C.  
 Sprague Specialties Co.  
**TDBE DEUTSCHMANN CORP.**, Canton, Mass.

## CONDENSERS, FIXED ELECTROLYTIC

**AEROVOX CORP.**, 90 Washington St., Brooklyn, N. Y.  
 Condenser Corp. of America  
**CORNELL-DUBILIER CORP.**, 4388 Bronx Blvd., N. Y. C.

**CURTIS CONDENSER CORP.**, 3088 W. 106th St., Cleveland, Ohio

**Magnavox Co., Ltd.**  
**MALLORY & CO., P. R.**, Indianapolis, Indiana  
 Micaemold Radio Corp.  
 Polymet Mfg. Co., Inc.  
**SOLAR MFG. CORP.**, 599-601 Broadway, N. Y. C.  
 Sprague Specialties Co.

## CONDENSERS, ADJUSTABLE

**DeJur-Ameco Corp.**  
**HAMMARLUND MFG. CO.**, 424 W. 33rd St., N. Y. C.  
 Melstner Mfg. Co.  
**SOLAR MFG. CORP.**, 599-601 Broadway, N. Y. C.  
**TDBE DEUTSCHMANN CORP.**, Canton, Mass.

## CONDENSERS, VARIABLE

**CARDWELL MFG. CO., ALLEN B.**, 81 Prospect St., Brooklyn, N. Y.  
**DeJur-Ameco Corp.**  
 General Instrument Co.  
**GENERAL RADIO CO.**, 30 State St., Cambridge, Mass.  
**HAMMARLUND MFG. CO.**, 424 W. 33rd St., N. Y. C.  
**QAK MFG. CO.**, 711 W. Lake Street, Chicago, Ill.  
 Prelias Mfg. Co.  
 Radio Condenser Co.  
 Reliance Die & Stamping Co.

## CONTACTS, METAL

Baker & Co., Inc.  
**CALLITE PRODUCTS DIV.**, 542 39th St., Union City, N. J.  
 General Plate Co.  
 General Tunstun Mfg. Co.  
**MALLORY & CO., P. R.**, Indianapolis, Indiana  
 Wilson Co., H. A.

## CORES, RESISTANCE COIL

**AMERICAN LAVA CORP.**, Chattanooga, Tenn.  
 Colonial Insulator Co.  
**ISOLANTITE, INC.**, 233 Broadway, N. Y. C.  
 Steward Mfg. Co.

## CORES, TRANSFORMER

**THOMAS & SKINNER STEEL PRODS. CO.**, 1100-1120 E. 23rd St., Indianapolis, Indiana

## CRYSTALS, QUARTZ and ROCHELLE SALT

**BLEY ELECTRIC CO.**, 337 Union Station Bldg., Erie, Pa.  
 Ronnton Research Labs.  
**BRUSH DEVELOPMENT CO.**, E. 40th St. & Perkins Ave., Cleveland, Ohio  
**PREMIER CRYSTAL LAB.**, 55 Park Row, N. Y.  
**RCA MANUFACTURING CO., INC.**, Camden, N. J.  
**SCIENTIFIC RADIO SERVICE**, University Pk., Hyattsville, Md.

## DIALS, ESCUTCHEONS

Crowe Nomenclature Co.  
**KAY PRODUCTS OF AMER., INC.**, 3901 Queens Blvd., Long Island City, N. Y.  
 Magnavox Company, The

## DIAPHRAGMS, SPEAKER

Hawley Products Co.  
 Masland Mfg. Corp.  
**UNITED PRESSED PRODUCTS CO.**, 407 S. Aberdeen St., Chicago, Ill.

## ELECTRODES, NEON

**EISLER ELECTRIC CORP.**, Union City, N. J.  
**EISLER ENGINEERING CO., INC.**, 747 So. 13th St., Newark, N. J.  
**SWEDISH IRON & STEEL CORP.**, 17 Battery Pl., N. Y. C.

## EYELETS

Platt Bros. & Co.

**STUPAKOFF LABS., INC.**, 6627 Hamilton Ave., Pash., Pa.

United Shoe Mach. Co.  
**WATERBURY BRASS GOODS BR.**, Waterbury, Conn.  
**FIBRE, PHENOL and VULCANIZED**  
 Bakelite Corp.  
 Brandywine Fibre Products Co.  
 Continental-Diamond Fibre Co.  
 Formica Insulation Co.  
 Franklin Fibre-Lamite Corp.  
 General Electric Co.  
 National Vulcanized Fibre Co.  
 Resinex Corporation  
**SYNTHANE CORPORATION**, Oaks, Penna.  
**TAYLOR & CO., INC.**, Norristown, Pa.  
 Westinghouse Elec. & Mfg. Co.  
 Wilmington Fibre Co.

## FLUXIBLE SHAFTING

Fischer Spring Company, Chas.  
 White Dental Mfg. Co., S. S.

## FUSES

**LITTELFUSE LABS.**, 4244 Lincoln Ave., Chicago, Ill.

## GENERATORS

**CARTER MOTOR COMPANY**, 373 W. Superior St., Chicago, Ill.  
**ELECTRONIC LABORATORIES, INC.**, 123 W. New York St., Indianapolis, Ind.  
**MALLORY & CO., P. R.**, Indianapolis, Indiana  
**OWEN & SOUS D.**, Minneapolis, Minn.  
**PIONEER GEN.-E. MOTOR CORP.**, 468 W. Superior St., Chicago, Ill.

## GETTERS (See Nickel Tube Parts)

## GRAPHITE

**ACHESON COLLOIDS CORP.**, Port Huron, Mich.

## HORNS

**ATLAS SOUND CORP.**, 1449—39th St., B'klyn, N. Y.  
**FOX SOUND EQUIP. CORP.**, 3120 Monroe St., Toledo, Ohio  
**GENERAL ILLUMINATING CORP.**, 16 Calender St., Providence, R. I.  
**HOPE MFG. CO.**, 98 Park Place, N. Y. C.  
**HACON ELEC. MFG. CO.**, 82 E. 19th St., N. Y. C.  
**WRIGHT-DECOSTER, INC.**, 2233 University Ave., St. Paul, Minn.

## INSTRUMENTS (See Meters or Cathode Ray)

### INSULATION, BEADS

**AMERICAN LAVA CORP.**, Chattanooga, Tenn.  
**ISOLANTITE, INC.**, 233 Broadway, N. Y. C.  
 Kirchner & Co., Inc., M.  
**STUPAKOFF LABORATORIES, INC.**, 6627 Hamilton Ave., Pitts., Pa.

### INSULATION, CERAMICS (See Ceramics)

### INSULATION COMPOUNDS

Candy & Co., Inc.  
 Dolph Co., John C.  
 Glenn & Co., J. J.  
 Mica Insulator Co.  
**STUPAKOFF LABS., INC.**, 6627 Hamilton Ave., Pash., Pa.  
**ZOPHAR MILLS, INC.**, Court, Lorraine and Creamer St., Brooklyn, N. Y.

### INSULATION, LAMINATED BAKELITE

Franklin Fibre-Lamite Corp.  
**SYNTHANE CORPORATION**, Oaks, Penna.  
**TAYLOR & CO., INC.**, Norristown, Pa.

### INSULATION, MOLDED

American Insulator Corp.  
**AMERICAN LAVA CORP.**, Chattanooga, Tenn.  
 American Phenolic Corp.  
 American Record Corp.  
 Chicago Molded Prods. Corp.  
 Formica Insulation Co.  
 Kurz-Kasch Co.  
 Macellen Co.  
**STUPAKOFF LABS., INC.**, 6627 Hamilton Ave., Pash., Pa.

### INSULATION, FABRIC TUBING

**BENTLEY HARRIS MFG. CO.**, Conshohocken, Pa.  
**BRAND & CO., WM.**, 276 Fourth Ave., N. Y. C.  
 Glenn & Co., J. J.  
 Mica Insulator Co.

### IRON, SWEDISH (Tube Parts)

**SWEDISH IRON & STEEL CORP.**, 17 Battery Pl., N. Y. C.

### LACQUER, PAINT, VARNISH

**ACME WIRE COMPANY**, 1255 Dixwell Ave., New Haven, Conn.  
 Dolph & Co., John C.  
 Irvington Varnish Co.  
 Mass & Wallstein  
**ZAPON COMPANY**, 60 E. 42nd St., N. Y. C.  
**ZOPHAR MILLS**, Court, Lorraine and Creamer Sts., Brooklyn, N. Y.

### LAMPS, GLOW

**LITTELFUSE LABS.**, 4244 Lincoln Ave., Chicago, Ill.

### LUGS

**CINCH MFG. CORP.**, 2335 W. Van Buren St., Chicago, Ill.  
 Thompson-Bremer Corp.  
**WATERBURY BRASS GOODS BR.**, Waterbury, Conn.  
**ZIERICK MACHINE WORKS**, 68 E. 151 St., N. Y. C.



# ENGINEERS!

*you should read*

## COMMUNICATION and BROADCAST ENGINEERING

*each month, to keep posted on latest developments in Broadcasting, Recording, Radio Communication, Facsimile, Police, Marine and Aeronautical Radio, Telegraphy and Telephony, Television, etc.*

**NOTE** the following features contained in the June issue—they're typical of each number:

- NAB Convention
- Television Demonstration
- New Aircraft Receiver
- Radio Equipment on the "Queen Mary"
- Fundamentals in the Applications of Matrices to Electrical Networks
- Ultra-High-Frequency, Multi-Channel Circuit
- High-Frequency Wave Guide
- Transmission Line Calculations
- FCC Allocation Hearing

*We will be pleased to send you a sample copy—  
with our compliments — just drop us a note.*

**BRYAN DAVIS PUBLISHING CO.**  
19 EAST 47TH STREET      NEW YORK, N. Y.

Subscription rates, \$3.00 one year  
\$5.00 two years  
(Foreign \$4.00 one year; \$7.00 two years)

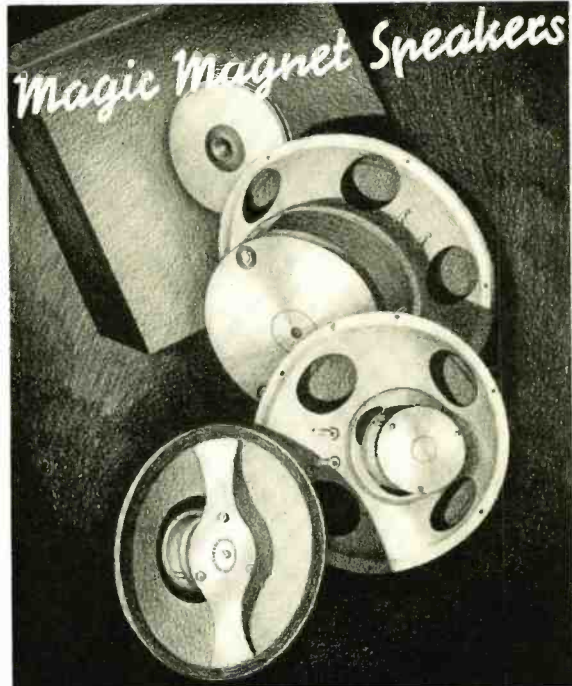

Complete technical data and quantity quotations gladly supplied, on the complete Cinaudagraph line of MAGIC MAGNET SPEAKERS. Line includes speaker sizes from 8 to 18 inches.  
**CINAUDAGRAPH CORPORATION**  
SPEAKER DIVISION      Department "E"      STAMFORD, CONN.

### CINAUDAGRAPH

Here Next Month:

## Tru-Fidelity

by

**THORDARSON**

Most Sensational  
Audio Development  
in Radio History

## LOWER COSTS



Available in  
1, 5 and 20  
lb. spools.

are made possible through the use of Gardiner Rosin-Core Solder. Its uniform high quality permits faster and neater work—saving both time and material.

In addition, because of modern production methods, Gardiner Solder actually costs less than even ordinary kinds.

Made in various alloys, core sizes and gauges.

Eastern Sales Office and Warehouse

**DAVID M. KASSON & CO.**

261 Canal Street, New York



4819 SO. CAMPBELL AVENUE, CHICAGO, ILL.

## MAGNETS

THOMAS & SKINNER STEEL PRODS. CO., 1100-1120 E. 23rd St., Indianapolis, Indiana.

## MELTING POTS

STA-WARM ELECTRIC CO., Ravenna, Ohio  
Trent Co., Harold E.

## METERS; TESTING INSTRUMENTS

BURTON-ROGERS CO., 755 Boylston St., Boston, Mass.  
CLOUGH-BRENLE CO., 1134 W. Austin Ave., Chicago, Ill.  
FERRIS INSTR. CORP., Boonton, N. J.  
GENERAL RADIO COMPANY, 30 State St., Cambridge, Mass.  
NICKOK ELEC. INSTRU. CO., Cleveland, Ohio  
JACKSON ELEC. INSTRU. CO., Dayton, Ohio  
RCA MFG. CO., INC., Camden, N. J.  
RADIO CITY PRODUCTS CO., 89 Park Place, N. Y. C.  
RADIO PRODUCTS CO., 145 Sunrise Pl., Dayton, Ohio  
READRITE METER WORKS, Bluffton, Ohio  
SOLAR MFG. CO., 599 B'way, N. Y. C.  
SUPREME INSTRUMENT CORP., Greenwood, Miss.  
TRIPLETT ELEC. INSTRU. CO., Bluffton, Ohio  
TRIUMPH MFG. CO., 4017 W. Lake St., Chicago, Ill.  
WESTERN ELECTRIC CO., 195 Broadway, N. Y. C.  
WESTON ELEC. INSTRU. CORP., 612 Frelingshuysen Ave., Newark, N. J.

## MICA

BRAND & CO., WM., 276 Fourth Ave., N. Y. C.  
Macellen Co.  
Mica Insulator Co.  
New England Mica Co.

## MICROPHONES

American Microphone Co.  
AMPERITE CORP., 561 Broadway, N. Y. C.  
ASTATIC MICROPHONE LAB., INC., 830 Market St., Youngstown, Ohio  
BRUSH DEVELOPMENT CO., Cleveland, Ohio  
Color-Tone, Inc.  
EASTERN SOUND CO., 94 Portland St., Boston.  
ELECTRO-VOICE MFG. CO., INC., South Bend, Indiana  
RADIO RECEPTOR CO., INC., 106 7th Ave., N. Y. C.  
RCA MFG. COMPANY, INC., Camden, N. J.  
SHURE BROS. CO., 215 W. Huron St., Chicago, Ill.  
SOUND SYSTEMS, INC., 6545 Carnegie Ave., Cleveland, Ohio  
TURNER COMPANY, Cedar Rapids, Ia.  
UNIVERSAL MICROPHONE CO., LTD., Inglewood, Calif.  
WESTERN ELECTRIC CO., 195 Broadway, N. Y. C.

## MOLYBDENUM

AMERICAN ELECTRO METAL CORP., Lewiston, Maine  
CALLITE PRODUCTS DIV., 542 39th St., Union City, N. J.  
ELECTRO-METALS, INC., 1880 E. 40 St., Cleveland, O.  
Finsteel Metallurgical Labs.

## NICKEL, TUBE PARTS (Also see SVEA Metal)

(plates, grids, wire cloth, cathodes, getters, hooks, heaters, base-plugs, welds)  
AMERICAN BRASS CO., Waterbury, Conn.  
AMERICAN ELECTRO METAL CORP., Lewiston, Maine  
CALLITE PRODUCTS DIV., 542 39th St., Union City, N. J.  
Cleveland Wire Cloth & Mfg. Co.  
Driver Co., Wilbur B.  
Driver-Harris Co.  
General Plate Co.  
GOAT RADIO TUBE PARTS, INC., 314 Dean St., Brooklyn, N. Y.  
King Laboratories, Inc.  
NEWARK WIRE CLOTH CO., Newark, N. J.  
SUMMERILL TUBING COMPANY, Bridgeport, Penna.  
SUPERIOR TUBE COMPANY, Norristown, Penna.

## PAPER, for CONDENSERS

Dexter & Sons Co., Inc., C. H. Schwelzler, Inc., Peter J. Strype, Fred. C.

## PAPER TUBES

Chicago Paper Tube Co.  
Crosa Paper Products Co.  
Paper Tube Company, The  
Paramount Paper Tube Co.

## PHOSPHOR BRONZE

Phosphor Bronze Smelting Co.  
Riverside Metal Company  
Seoville Mfg. Company  
Seymour Mfg. Company  
Waterbury Rolling Mills, Inc.

## PHOTOELECTRIC CELLS

Burt, R. C., Co.  
Continental Electric Co.  
Eby Mfg. Co., H. H.  
General Electric Co.  
DR. F. LOEWENBERG, 10 E. 40th St., N. Y. C.  
RCA MANUFACTURING CO., INC., Camden, N. J.  
Westinghouse Elec. & Mfg. Co.  
WESTON ELECTRICAL INSTRUMENTS CORP., 612 Frelingshuysen Ave., Newark, N. J.

## PICKUPS, TRANSCRIPTION

ASTATIC MICROPHONE LAB., INC., 830 Market St., Youngstown, Ohio  
AUDAK COMPANY, THE, 500 Fifth Ave., N. Y. C.  
FAIRCHILD-PROCTOR PRODUCTS, 17 W. 60th St., N. Y. C.  
PRESTO RECORDING CO., 139 W. 19th St., N. Y. C.  
RCA MFG. COMPANY, INC., Camden, N. J.  
Weston Electric Co.

## PLASTICS (See Insulation, Molded)

## PLUGS

ALDEN PRODUCTS CO., Brockton, Mass.  
American Phenolic Corp.  
Cannon Elec. Development Co.

CINCH MFG. CORP., 2335 W. Van Buren St., Chicago, Ill.

Eby Mfg. Co., H. H.  
MALLORY & CO., INC., P. R., Indianapolis, Indiana  
REMLER CO. LTD., 2101 Bryant St., San Francisco, Calif.

## POINTS CONTACT

Baker & Company  
CALLITE PRODUCTS DIV., 542 39th St., Union City, N. J.  
Finsteel Metallurgical Corp.

## RECTIFIERS

B-I Electric Mfg. Co.  
GENERAL ELECTRIC CO., Bridgeport, Conn.  
MALLORY & CO., INC., P. R., Indianapolis, Indiana  
UNITED TRANSFORMER CORP., 72-74 Sprink St., N. Y. C.  
Westinghouse Elec. & Mfg. Co.  
WARD LEONARD ELEC. CO., Mt. Vernon, N. Y.

## RELAYS

ALLEN-BRADLEY CO., 126 W. Greenfield Ave., Milwaukee, Wis.  
Automatic Electric Co.  
Dunn, Inc., Struthers  
ELECTRONIC LABORATORIES, INC., Indianapolis, Ind.  
GENERAL ELECTRIC COMPANY, Schenectady, N. Y.  
Kurman Elec. Co.  
WARD LEONARD ELEC. CO., Mt. Vernon, N. Y.  
WESTON ELEC. INSTRU. CORP., 612 Frelingshuysen Ave., Newark, N. J.

## RESISTORS, CARBON-COMPOSITION

AEROVOX CORP., 90 Washington St., Brooklyn, N. Y.  
ALLEN-BRADLEY CO., 126 W. Greenfield Ave., Milwaukee, Wis.  
CENTRAL AB, 900 E. Keefe Ave., Milwaukee, Wis.  
Chicago Te. Supply Co.  
CLAROSTAT MFG. CO., INC., 287 N. 6th St., Brooklyn, N. Y.  
CONTINENTAL CARBON, INC., 13902 Lorain Ave., Cleveland, Ohio  
ELECTRAD, INC., 175 Varick St., N. Y. C.  
ERIE RESISTOR CORP., Erie, Penn.  
INTERNATIONAL RESISTANCE CO., 2100 Arch St., Phila., Pa.  
MALLORY & CO., INC., P. R., Indianapolis, Indiana  
Micromold Radio Corp.  
Ohio Carbon Co.  
OHMITE MFG. CO., 4835 Flournoy St., Chicago, Ill.  
Stackpole Carbon Co.  
SOLAR MFG. CO., 599-601 Broadway, N. Y. C.  
WARD LEONARD ELEC. CO., 35 South St., Mt. Vernon, N. Y.  
White Dental Mfg. Co., S. S.  
Wirt Company, The

## RESISTORS, WIRE WOUND

AEROVOX CORP., 90 Washington St., Brooklyn, N. Y.  
CLAROSTAT MFG. CO., INC., 287 N. 6th St., Brooklyn, N. Y.  
Daven Company  
ELECTRAD, INC., 175 Varick St., N. Y. C.  
INTERNATIONAL RESISTANCE CO., 2100 Arch St., Phila., Pa.  
MALLORY & CO., INC., P. R., Indianapolis, Indiana  
MUTER CO., THE, 1255 S. Michigan Ave., Chicago, Ill.  
OHMITE MFG. COMPANY, 4835 Flournoy St., Chicago, Ill.  
Precision Resistor Co.  
Shallcross Mfg. Co.  
WARD LEONARD ELEC. CO., Mt. Vernon, N. Y.  
Wirt Company, The

## SCREW DRIVER MACHINERY

HASKINS CO., R. G., 4633 W. Fulton St., Chicago, Ill.

## SCREWS, SELF LOCKING

Parker-Kalon Corp.  
SHAKEPROOF LOCK WASHER CO., 2501 N. Keeler Ave., Chicago, Ill.

## SOCKETS

ALDEN PRODUCTS CO., Brockton, Mass.  
American Phenolic Corp.  
CINCH MFG. CORP., 2335 W. Van Buren St., Chicago, Ill.  
Continental-Diamond Fibre Co.  
Eby Mfg. Co., H. H.  
FRANKLIN MFG. CORP., ALBERT W., 160 Varick St., N. Y. C.

## SOLDER

Dutton Co., M. W.  
GARDNER METAL CO., 4819 S. Campbell Ave., Chicago, Ill.  
Kester Solder Company  
RUBY CHEMICAL CO., 56 McDowell St., Columbus, Ohio.

## SOLDERING IRONS

ELECTRIC SOLDER IRON CO., 342 W. 14th St., N. Y. C.  
STA-WARM ELECTRIC CO., Ravenna, Ohio

## SPEAKERS and SPEAKER UNITS

Best Mfg. Co.  
Baudette & Co.  
CINAUDAGRAPH CORP., Stamford, Conn.  
CONTINENTAL MOTORS CORP., 10801 E. Jefferson St., Detroit, Mich.  
FOX SOUND EQUIP. CORP., 3129 Monroe St., Toledo, Ohio.  
Jensen Radio Mfg. Co.  
Mazeros Co.  
OPERADIO MFG. CO., 13th and Indiana St., St. Charles, Ill.  
OXFORD-TARTAK RADIO CORP., 915 W. Van Buren St., Chicago, Ill.  
RCA MFG. COMPANY, INC., Camden, N. J.  
RADON ELEC. CO., INC., 52 E. 19th St., N. Y. C.  
Rola Common, The  
UTAH RADIO PRODUCTS CO., 820 Orleans St., Chicago, Ill.  
WESTERN ELECTRIC CO., 195 Broadway, N. Y. C.  
WRIGHT-DE GOSTER, INC., 2253 University St., St. Paul, Minn.

## STEEL

Allegheny Steel Co.  
AMERICAN ROLLING MILL CO., Middletown, Ohio  
American Steel & Wire Co.  
Republic Steel Corp.  
Ryerson & Son, Inc.

## SVEA METAL

SWEDISH IRON & STEEL CORP., 17 Battery Pl., N. Y. C.

## TAPE, VARNISHED FABRIC

ACME WIRE CO., 1255 Dixwell Ave., New Haven.  
BRAND CO., WILLIAM, 276 Fourth Ave., N. Y. C.  
TRANSFORMERS (Also see Chokes)  
ACME ELEC. & MFG. CO., THE, 1440 Hamilton Ave., Cleveland, Ohio  
AMERICAN TRANS. CO., 175 Emmet St., Newark, N. J.  
Chicago Transformer Co.  
FERRANTI ELECTRIC, INC., 30 Rockefeller Plaza, N. Y. C.  
GENERAL TRANS. CORP., 502 S. Throop St., Chi., Ill.  
HALLDRONSON COMPANY, THE, 4500 Ravenswood Ave., Chicago, Ill.  
JEFFERSON ELECTRIC CO., Bellwood, Illinois  
Kenyon Transformer Corp.  
RCA MFG. COMPANY, INC., Camden, N. J.  
STANDARD TRANS. CORP., 866 Blackhawk St., Chi., Ill.  
THORADSON ELEC. MFG. CO., 500 W. Huron St., Chicago, Ill.  
UNITED TRANS. CORP., 72-74 Spring St., N. Y. C.

## TRANSPORTATION, EXPRESS

Railway Express Agency, Inc. Offices in all cities

## TUBE PARTS (See Iron and Nickel)

## TUBING, SEAMLESS CATHODE

General Plate Company  
SUMMERILL TUBING COMPANY, Bridgeport, Pa.  
SUPERIOR TUBE COMPANY, Norristown, Pa.

## TUBING SPAGHETTI (See Insulation Tubing)

## TUNGSTEN

CALLITE PRODUCTS DIV., 542 39th St., Union City, Cleveland Tungsten Mfg. Co., Inc.

## VIBRATORS (See Relays)

## WASHERS INSULATING (See Fibre, Phenol)

## WASHERS, METAL

Reliance Mfg. Co.  
SHAKEPROOF LOCK WASHER CO., 2501 N. Keeler Ave., Chicago, Ill.  
Thompson-Bremer Corp.  
WROUGHT WASHER MANUFACTURING CO., 2203 B. Bay St., Milwaukee, Wis.

## WAXES (See Insulation, Compounds)

## WIRE, BARE

Alpha Wire Co.  
American Braiding Co.  
American Steel & Wire Co.  
ANACONDA WIRE & CABLE CO., 25 B'way, N. Y. C.  
Belden Mfg. Co.  
CALLITE PRODUCTS DIV., 542 39th St., Union City, N. J.  
CORNISH WIRE COMPANY, 30 Church St., N. Y. C.  
Crecent Insulated Wire & Cable Co.  
General Cable Corp.  
Holyoke Company, Inc.  
Hoskins Mfg. Co.  
Phosphor Bronze Smelting Co.  
Hoebling's Sons Co., John A.

## WIRE, BRAIDED

American Braiding Co.  
CORNISH WIRE COMPANY, 30 Church St., N. Y. C.  
General Cable Corp.  
Holyoke Company, Inc.  
Hoebling's Sons Co., John A.

## WIRE, COPPER CLAD

American Braiding Company  
CALLITE PRODUCTS DIV., 542 39th St., Union City, N. J.

## WIRE, FILAMENT and GRID

AMERICAN ELECTRO METAL CORP., Lewiston, Maine  
CALLITE PRODUCTS DIV., 542 39th St., Union City, N. J.  
Driver Co., Wilbur B.  
Driver-Harris Co.  
NEWARK WIRE CLOTH CO., Newark, N. J.  
Prentiss & Co., Geo. W.  
SWEDISH IRON & STEEL CORP., 17 Battery Pl., N. Y. C.

## WIRE, INSULATED

ACME WIRE COMPANY, 1255 Dixwell Ave., New Haven, Conn.  
American Braiding Company  
American Enameled Magnet Wire Co.  
American Steel & Wire Co.  
ANACONDA WIRE & CABLE CO., 25 B'way, N. Y. C.  
Belden Mfg. Co.  
CORNISH WIRE COMPANY, 30 Church St., N. Y. C.  
GENERAL ELECTRIC COMPANY, Schenectady, N. Y.  
LENZ ELECTRIC MFG. CO., 1751-1757 N. Western Ave., Chicago, Ill.  
Rockbestos Products Corp.  
Roebbing's Sons Co., John A.

## WIRE, LEAD-IN

ELECTRO METALS, INC., 1880 East 40th St., Cleveland, Ohio.

## WIRE, MAGNET

ACME WIRE COMPANY, 1255 Dixwell Ave., New Haven, Conn.  
American Braiding Co.  
American Enameled Magnet Wire Co.  
American Steel & Wire Co.  
ANACONDA WIRE & CABLE CO., 25 B'way, N. Y. C.  
Belden Mfg. Co.  
General Cable Corp.  
GENERAL ELECTRIC COMPANY, Schenectady, N. Y.  
Roebbing's Sons Co., John A.

## WIRE, RESISTANCE (See Alloys)

## WIRE STRIPPERS

Carlander, Henry  
WIRE STRIPPER CO., 1725 Eastham Ave., East Cleveland, Ohio.

## ZINC

New Jersey Zinc Co.  
Platt Bros. & Co.

# MANUFACTURERS—

2,000 of them—large and small—are paid subscribers to *RADIO ENGINEERING*.

Some of these manufacturers are assemblers of receivers, sound and recording equipment, amplifiers, transmitters, etc. Hundreds of these manufacturers make components and accessories.

That's why manufacturers of *materials* find *RADIO ENGINEERING* their best advertising medium—for "production line" sales.

(For July advertising, forms close July 6.)

## Devine Impregnating Equipment Bargains

Formerly used by large transformer manufacturer

3-60 gal., 1-125 gal. 250 lb. pressure vacuum tanks  
1-125 gal. liquor tank; 1-60 gal. Devine vacuum  
Pump and dipping baskets  
1-automatic variable speed 9 coil winding machine  
at a fraction of cost—Wire or write

SURPLUS CORP., 89 Greenpoint Ave., Brooklyn, N. Y.

## BLILEY QUARTZ CRYSTALS

For general and special radio frequency applications between 20Kcs and 20Mcs.

Write for Bulletin G-8  
BLILEY ELECTRIC CO.  
ERIE, PA.

Here Next Month:  
**Tru-Fidelity**

by  
**THORDARSON**

Most Sensational  
Audio Development  
in Radio History



**VULCANIZED FIBRE  
PHENOL FIBRE  
TAYLOR INSULATION**

TAYLOR & CO., INC. Norristown, Pa.

# FRANCE

Importers want agency of U. S. A. manufacture of radio parts especially volume controls, fixed condensers and resistors.

ELMA 10, Rue Théophraste Renaudot PARIS 15 (France).

QUALITY WELDS and  
LEAD-IN WIRES

## ELECTRO-METALS, Inc.

1880 East 40th Street

Cleveland, Ohio

*Candohms*  
ARMOURD WIRE  
WOUND RESISTORS  
OVER ELEVEN  
MILLION IN USE

MAY WE SAMPLE AND QUOTE?

**MUTER**

THE MUTER COMPANY  
1255 SO. MICHIGAN AVENUE  
CHICAGO

## INDEX TO ADVERTISERS

<b>A</b>	
Acme Elec. & Mfg. Co., The.....	27
Acme Wire Co.....	29
Allen-Bradley Co.....	Fourth Cover
American Brass Co., The.....	27
American Lava Corp.....	Second Cover
<b>B</b>	
Bliley Electric Co.....	33
Brand & Co., Wm.....	29
<b>C</b>	
Callite Products Co.....	27
Cinaudagraph Corp.....	31
Clarostat Mfg. Co., Inc.....	17

<b>E</b>	
Electro Metals, Inc.....	33
Elma.....	33
<b>G</b>	
Gardiner Metal Co.....	31
General Radio Co.....	Third Cover
<b>M</b>	
Morlen Elec. Co., Inc.....	3
Muter Company, The.....	33
<b>R</b>	
Railway Express Agency, Inc.....	4

<b>S</b>	
Shakeproof Lock Washer Co.....	4
Surplus Corp.....	33
<b>T</b>	
Taylor & Co., Inc.....	33
Thordarson Mfg. Co.....	27-29-31-33
<b>W</b>	
Waterbury Brass Goods Branch....	27
<b>Z</b>	
Zophar Mills, Inc.....	27



**T**HE Group Subscription Plan for RADIO ENGINEERING enables a group of engineers or department heads to subscribe at one-half the usual yearly rate.

The regular individual rate is \$2.00 a year. In groups of 4 or more, the subscription rate is \$1.00 a year. (In foreign countries, \$2.00.)

---

The engineering departments of hundreds of manufacturers in the radio and allied industries have used this Group Plan for years, in renewing their subscriptions to RADIO ENGINEERING.

---

Each subscriber should print his name and address clearly and state his occupation—whether an executive, engineer, department head, plant superintendent, or foreman, etc.

**Remember this Group Plan  
when *Your* Subscription Expires**

*(Radio Engineering)*

**BRYAN DAVIS PUBLISHING CO., Inc.**

19 East 47th Street, New York, N. Y.

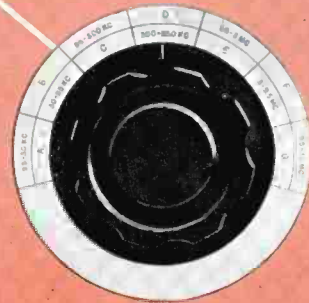
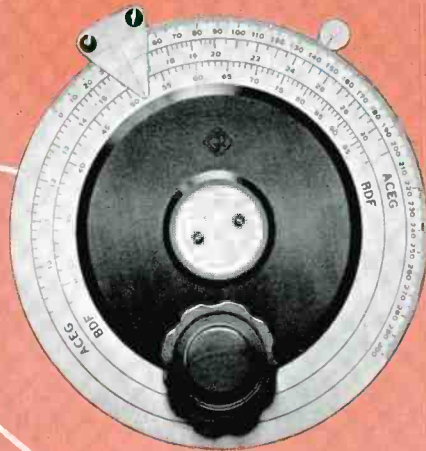

DIRECT READING  
10 kc to 30 Mc

## A NEW G-R STANDARD-SIGNAL GENERATOR

Announced after several years of development—a moderately priced "all-wave" standard-signal generator with many electrical and mechanical improvements.

Simple to operate—accurately calibrated—thoroughly shielded—the new General Radio Type 605-A Standard-Signal Generator has all the conveniences you have been asking for.

Check these features:

- ★ DIRECT READING—no calibration curves to read—no plug-in coils.
- ★ A-C OPERATED—built-in voltage regulator—line voltage fluctuations have no effect upon frequency.
- ★ CONTINUOUS FREQUENCY RANGE—10 kc to 30 Mc.
- ★ INTERNAL OR EXTERNAL MODULATION—internal fixed at 400 cycles; external, flat from 30 cycles to 15 kc.
- ★ NO FREQUENCY MODULATION.
- ★ NO REACTION OF ATTENUATOR ON FREQUENCY.
- ★ NO THERMOCOUPLES—vacuum-tube voltmeter indicates carrier amplitude—cannot be burned out.

PRICE: Type 605-A Standard-Signal Generator: \$415.

Complete with accessories and tubes.  
Specify a-c or battery model.

Write for Bulletin 23-Y for Complete Description

Address:

**GENERAL RADIO COMPANY**  
30 State Street, Cambridge, Massachusetts

## SPECIFICATIONS

Circuit: Master—oscillator—amplifier.

Frequency Calibration: Direct-reading to 1%. Straight-line logarithmic frequency scale.

Output Voltage Range: 0.5 microvolt to 0.1 volt.

Output System: 10-ohm constant resistive from 0 to 0.01 volt and constant 50-ohm from 0.01 to 0.1 volt.

Modulation: Continuously variable to 50%. Settings accurate to  $\pm 10\%$ .

Stray Fields: Electrostatic and magnetic stray fields negligible.

Power Supply: Three a-c operated models available, for 60, 50 and 42 cycles. Built-in voltage regulator compensates for line voltage fluctuations between 100 and 130 volts.

Battery Operation: Battery operated model available for 200-volt plate and 6.3 volt filament supplies. Control panel contains plate and filament meters and necessary controls.

# GENERAL RADIO COMPANY

# CUT Your Chassis Assembly COSTS

Use Allen-Bradley Resistors in the New Indexed Cartons

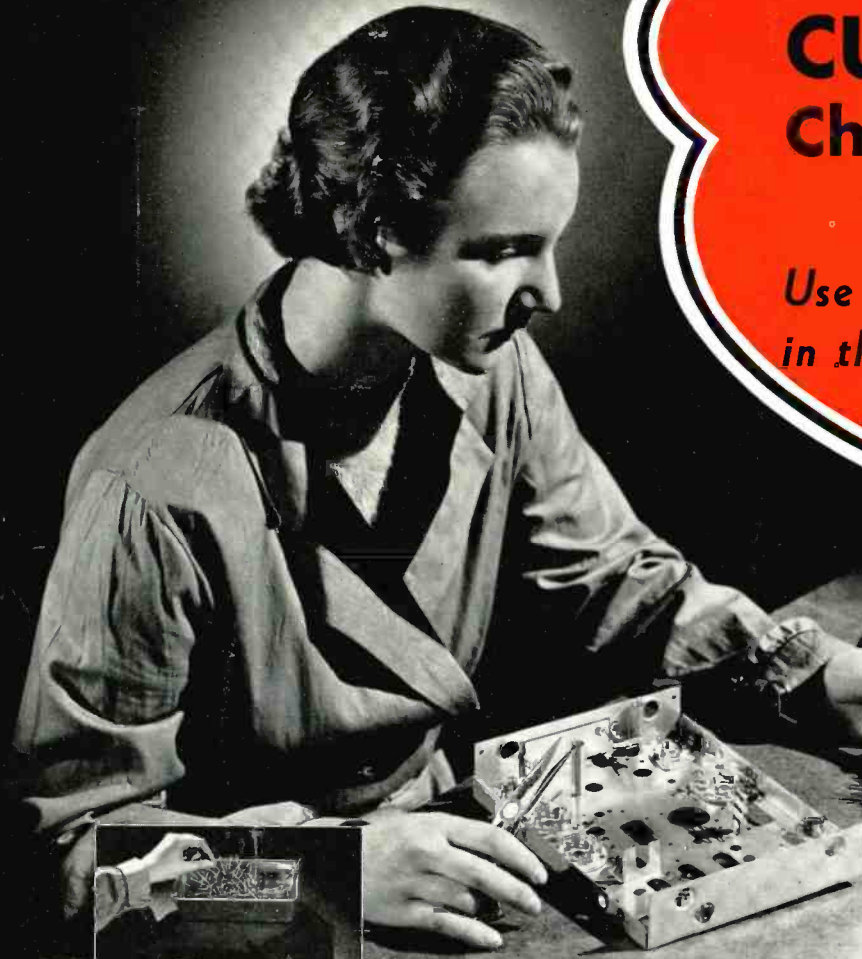

**OLD**—Jumbled resistors, bent leads, and delayed schedules.



**NEW**—Packaged resistors—straight leads, and faster schedules.

★ NO TANGLING OF RESISTOR LEADS

★ NO FUMBLING

★ NO DELAYS



How do you handle resistors in your chassis assembly lines? Are they a jumbled, tangled mass in stock pans—hard to count and even harder to pick up?

If so, modernize your production methods by standardizing on the new Allen-Bradley molded resistors. They are scientifically packaged in a new type of indexed carton that speeds up pro-

duction. Counting and weighing are eliminated.

Type E SOLID MOLDED RESISTOR (non-insulated) with straight-line leads molded into resistor. No sprayed copper connections—no soldered joints. Leads are specially tempered to prevent sharp bends at the resistor. Rating— $\frac{1}{2}$  watt.

Type CB INSULATED RESISTOR—same as Type E, plus molded bakelite insulation. Rating— $\frac{1}{2}$  watt.

Allen-Bradley Co.  
126 West Greenfield Avenue  
Milwaukee, Wis.

## ALLEN-BRADLEY RADIO RESISTORS



A carton of 500 Allen-Bradley Molded Resistors, ready for the assembly line.